

Canada-France-Hawaii Telescope

2011

**Annual
Report**



TABLE OF CONTENTS

CFHT STAFF (ON DEC 31ST, 2011) 3

CFHT GOVERNANCE - 3

BOARD OF DIRECTORS - 3

SCIENTIFIC ADVISORY COMMITTEE - 3

CFHT EXECUTIVE - 3

DIRECTOR'S MESSAGE - 4

ELIXIR-LSB & NGVS - 6

OBSERVATION OF MERCURY EXOSPHERE - 10

AN UNUSUAL VIEW: CFHT OBSERVING IN DAYLIGHT - 12

VENUS HIGH ATMOSPHERE FROM EARTH AND SPACE - 13

HOW HOT IS IT UNDER THE DOME? - 14

THIRTY YEARS AGO - 16

DOME VENTING PROJECT - 17

THE DOME DRIVES GO ELECTRIC! - 20

ONE YEAR OF REMOTE OPERATION: A REMOTE OBSERVER'S PERSPECTIVE - 21

NEW INSTRUMENTATION - 22

SITELLE - 22

SPIROU - 23

IMAKA - 24

GRACES - 25

TEN YEARS AGO... - 25

NEXT GENERATION CFHT - 26

OUTREACH - 28

COMINGS AND GOINGS - 29

2011 FINANCIAL RESOURCES - 30

TELESCOPES FROM AFAR - 31



CFHT Annual Report 2011 *Christian Veillet, Editor - © CFHT, 2012*

Front Cover Galaxies collide over hundreds of millions of years through a process called tidal stripping as galaxies reap each other apart. Falling in a very special class of these interactions, NGC 474 is called a shell galaxy due to stars creating well defined structures through some gravitational process. This image is a color-composite of Elixir-LSB products (Atlas3D) further enhanced by Coelum. © CFHT-Coelum

Back Cover Tidal interactions between galaxies, also qualified as collisions, play a crucial role in their physical and morphological evolution. Two galaxies are seen here in a close encounter, the spiral arms of the larger one being the star field. This image is a color-composite of Elixir-LSB products (NGVS) further enhanced by Coelum. © CFHT-Coelum

CFHT Staff (on Dec 31st, 2011)

Akana, Moani	Administrative Specialist	Manset, Nadine	Resident Astronomer
Arnouts, Stéphane	Resident Astronomer	Martoli, Eder	Resident Astronomer
Arruda, Tyson	Mechanical Technician	Matsushige, Grant	Sr. Instrument Specialist
Babas, Ferdinand	Assistant System Administrator	Mizuba, Les	Instrument Specialist
Baril, Marc	Instrument Engineer	Morrison, Glenn	Resident Astronomer
Barrick, Gregory	Optical Engineer	Potter, Sharon	Safety Specialist
Bauman, Steve	Operations Manager	Roberts, Larry	Electrician
Benedict, Tom	Instrument Specialist	Rodgers, Jane	Finance Manager
Burdullis, Todd	Senior Service Observer	Salmon, Derrick	Director of Engineering
Cruise, William	Telescope Control Systems Eng.	Stevens, Mercedes	Assistant to the Exec. Director
Cuillandre, J.-Charles	Staff Astronomer	Taroma, Ralph	Observatory Facility Manager
Dale, Laurie	Administrative Specialist	Teeples, Doug	System Programmer
Devost, Daniel	Director of Science Operations	Thanjavur, Karun	Resident Astronomer
Draginda, Adam	Service Observer	Thomas, James	Computer Systems Engineer
Elizares, Casey	Mechanical Technician	Veillet, Christian	Executive Director
Fischer, Linda	Resource Specialist	Vermeulen, Tom	Systems Programmer
Forshay, Peter	Service Observer	Warren, DeeDee	Director of Finance & Admin.
Ho, Kevin	Instrument Manager	Wells, Lisa	Observing Assistant
Lai, Olivier	Resident Astronomer	Withington, Kanoa	Software Manager
Look, Ivan	Mechanical Design Engineer	Wood, Roger	Automotive Mechanic
Mahoney, Billy	Data Base Specialist	Woodworth, David	Senior Observing Assistant

CFHT Governance

Board of Directors

Dr. Claude Catala (Chair) (2010 -2011) - Observatoire de Paris - LESIA
Dr. Stéphanie Côté - Herzberg Institute of Astrophysics
Dr. Jean-Gabriel Cuby (Secretary) (2010-2011)- Laboratoire d'Astrophysique de Marseille
Dr. Michael M. De Robertis (Vice-Chair) (2010-2011) - York University
Dr. Gregory G. Fahlman - Herzberg Institute of Astrophysics
Dr. Donald Straney - University of Hawaii
Dr. Jean-Marie Hameury - Institut National des Sciences de l'Univers
Dr. Robert A. McLaren (Treasurer) (2010-2011) - Institute for Astronomy, University of Hawaii
Dr. Harvey Richer - Department of Physics & Astronomy, University of British Columbia
Dr. Geneviève Soucail - Observatoire Midi-Pyrénées

Scientific Advisory Committee

Dr. John Blakeslee (TAC) - Dominion Astrophysical Observatory, Herzberg Institute of Astrophysics
Dr. Mark Chun - Institute for Astronomy, University of Hawaii
Dr. Thierry Contini (TAC) - Laboratoire Astrophysique de Toulouse-Tarbes
Dr. Pierre-Alain Duc - Service d'astrophysique, CEA Saclay
Dr. Brett Gladman (Chair) - Dept. of Physics and Astronomy, U. of British Columbia
Dr. Thierry Forveill (Vice-Chair) - Observatoire de Grenoble
Dr. Coralie Neiner (TAC) - LESIA, Observatoire de Paris
Dr. David B. Sanders (TAC) - Institute for Astronomy, University of Hawaii
Dr. Gregg A. Wade (TAC) - Department of Physics, Royal Military College of Canada
Dr. Jon Willis - Department of Physics and Astronomy, University of Victoria

CFHT Executive

Christian Veillet - Executive Director
Daniel Devost - Director of Science Operations
Derrick Salmon - Director of Engineering
DeeDee Warren - Director of Finance and Administration

Director's Message



Director Christian Veillet at his desk

Watercolour sketch by Colleen McLaughlin Barlow

2011 was a year made of a mix of completed projects on one side, important steps reached for others, and new beginnings from some: like a jumping board set on solid grounds!

We started the year by hosting at the Marriott Waikoloa *Telescopes from Afar*, a conference devoted to telescopes operating in various stages of operational remoteness: remote observations with staff on site, remote operation without human presence at the observatory, up to fully automated or robotic telescopes. It was very successful and organizing a second edition in a two- to three-year time scale appeared to all as a good idea.

Operation-wise, 2011 was a very smooth year with once more little time lost to technical issues. Since the completion in February of the first phase of the Observatory Automation Process (OAP), CFHT was operated from Waimea by a single RO (Remote Observer) with much success. No significant time was lost due this new operating mode. You will find a RO's view of remote operations here. At the summit, the dome was retrofitted with electric drives replacing the original hydraulic motors. The new system is more energy-efficient, easily controllable from Waimea, and requiring less maintenance, while mitigating the EPA risks related to oil leaks. The change was very smooth and did not even require giving up observing time when installed!

It will be hard to do better than the 2011 shutdown vintage which took place in August : the impressive preparation work made by so many clearly paid off, from database maintenance to puck rebuilding or mirror coating, just to name a few... The telescope was back on the sky for an essentially flow-less full night of science after only six nights without observations and seven long days of work! The mirror badly needed a thorough cleaning and a fresh coat of aluminium, as seen of the graph on the right showing the Mega-Cam zero point evolving with time in r' : it has been four years between the last coating (2007) and the new one, both marked by the red dashed lines.

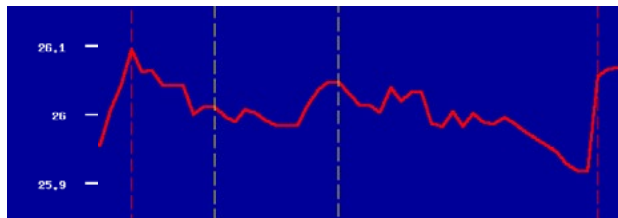

Following the choices made by CFHT's Board at its December 2010 meeting, SPIrou, an infra-red (up to K-band) spectro-polarimeter capable of 1-m/s precision radial velocity measurements, moved into Phase B. Much time and care were devoted to the development of a new project structure which would enable an efficient and smooth progress toward a Preliminary Design Review to happen in 2012.

SITELLE, a 10'x10' FTS imager developed at U. Laval, was given a jump start through an early financial support by the observatory while the team was waiting for the Canadian funding to make its way through the administration. The development progressed at a good pace. By the end of the year, SITELLE was on good tracks to indeed be on the sky toward the second half of 2013.

The next step in wide-field imaging at CFHT, 'IMAKA, moved forward at the feasibility level: more studies of possible optical designs and mechanical layouts and more simulations of this ground layer adaptive optics corrected wide-field imager showed the potential exceptional performances but extraordinary complexity of this instrument.

By the end of the year, the GRACES experiment (Gemini Remote Access to the CFHT ESPaDOnS Spectrograph) was given a green light by Gemini. Simulations and conceptual design studies have already shown that GRACES could provide interesting high-resolution spectroscopic capabilities to the Gemini users community at relatively low cost through a fiber link feeding ESPaDOnS from the Gemini telescope. An on-sky demonstration should take place for the winter 2012/2013.

The Dome Venting project moved at a good pace in 2011. A call for bids together with a draft contract form and technical



Realuminizing...

The mirror is ready for a thorough cleaning before moving in the vacuum chamber and receiving a fresh aluminium coating

specifications was issued in November, with an on-site pre-bid familiarization visit in early December. Selection of the contractor is scheduled for early 2012.

Much progress was made in 2011 on ngCFHT (next generation CFHT), a 10-m telescope dedicated to wide-field highly multiplexed spectroscopy to replace the 3.6-m while staying within the footprint and envelope of the current CFHT without any more harm done to Mauna Kea. More details on this exciting concept here!

On the science side, the number of CFHT-based publications was once more very high, approaching 130. Dennis Crabtree updated his statistics and devised new ways to look at the impact per telescope. The “Total Impact” is shown for the major observatories, still placing CFHT very high in the ranking, second only to Keck for this 2011 batch. A close look at the most cited publications shows that the most cited papers are mainly coming from large programs, namely the CFHTLS and COSMOS surveys in which CFHT is much involved. These same programs also benefit the impact of other observatories: it is the case of the VLT or Keck for the SNe component of the CFHTLS (SNLS), or Subaru and many others for COSMOS. With more and more scientific programs being based on data coming from many telescopes, the modest size facilities which devote a good fraction of their time to such endeavors are compensating their mirror size in impact-based metrics .

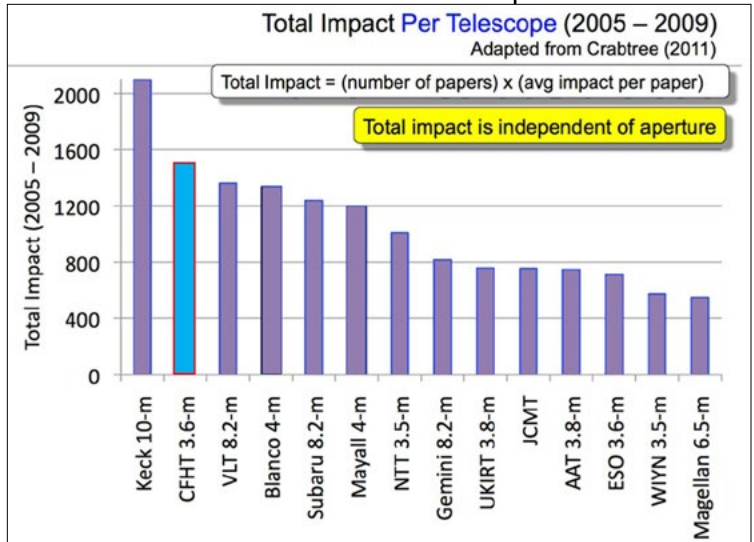

Before closing this message, I am very happy to mention the residency in March 2011 of CFHT’s first Artist in Residence, Colleen McLaughlin Barlow, an accomplished Canadian artist painter/sculptor/photographer/... Colleen spent a few weeks with us, following the various activities of the observatory at the headquarters and at the summit, and hanging around during night time observing. Soon after she arrived, she explained in a talk to the staff that she did not wish only to take from CFHT but also offer art experiences to staff. She offered four exercises to anyone who wished to participate: Sumi-e (Japanese ink brush painting of classic characters), Shodo (large scale sumi-e), Cyanotype Sun Printing (using our own nearest star to make art prints) and Continuous Landscape (five people divide a 360 degree view and draw it continuously in five booklets). In her open studio exhibition at the end of her stay in the headquarters conference room, her art as well as pieces by members of the staff were displayed for all to watch. A wonderful experience for Colleen, and for CFHT too!

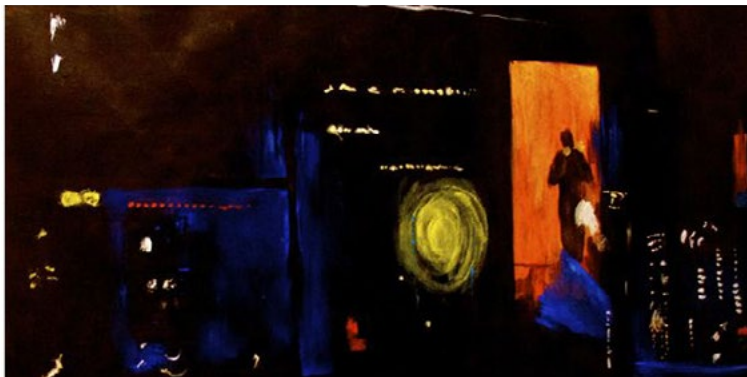

Night Observer - Acrylic on canvas by Colleen McLaughlin Barlow



Left: Sword Sumi-e

Ink on paper, by Colleen McLaughlin Barlow

Right: Open Studio exhibition

Colleen McLaughlin Barlow and a mix of her own work and staff pieces.



On the 30th of April 2012, I will complete my third and last term as Executive Director. Therefore this Annual Report is the last one I am editing. 2011 was a jumping board propelling CFHT into a new era of exciting developments which Doug Simons will successfully lead as next CFHT Executive Director. *Bon vent, Doug!*

Elixir-LSB & NGVS

Precision photometry of extended sources with MegaCam

J.-C. Cuillandre (CFHT) and L. Ferrarese (HIA)

Elixir: a point-source oriented pipeline

The photometric calibration implemented in the MegaCam pipeline (Elixir, Magnier & Cuillandre 2004) was developed and optimized for point source oriented scientific programs (stars and field galaxies with a maximum angular dimension of a few tens of arcseconds) in response to the demand from the scientific communities. Since the early advances of optical wide-field imaging at CFHT (MOCAM in 1994 quickly followed by the UH8K in 1995), such programs have largely dominated the landscape of scientific activities conducted on the CFHT (cosmology, solar system, stellar physics). The trend was further confirmed during the four years of CFH12K operations and then through the dominant program of the first 6 years of MegaCam operations, the CFHT Legacy Survey (CFHTLS). In such context, significant efforts were poured into ensuring the best photometric properties of the instrument for point sources. These efforts were driven in particular by the highly demanding photometric requirements of the SuperNovae Legacy Survey (SNLS, Astier et al. 2006) component of the CFHTLS, which needed systematic errors to be well understood, calibrated, and corrected. The collaborative effort between the SNLS team and CFHT resulted in feedback into the Elixir pipeline which can now deliver a better than 1% photometry flatness across the entire 1 square degree field of view in all filters for small sources (Regnault et al. 2009, Betoule et al. in preparation). Photometry of extended sources, i.e. larger than a

couple of arcminutes, is challenging in this context as the approach adopted in Elixir for photometric uniformity makes use of high quality (high SNR) twilight flat-fields exhibiting a natural radial gradient with variations of a few percents on a physical scale of several tens of arcseconds. The radial pattern originates from scattered light due to reflections in the prime focus optics (MegaPrime: a 4-lens wide field corrector, a tip-tilt plate, and the MegaCam camera window and filters). Moreover, this flat-field is convolved with a photometric map delivering the required uniformity of the zero-point across the entire field of view, a correction that exacerbates the native radial pattern. The resulting peak-to-peak variation in the number of counts for a uniform illumination source is between 15% and 25% of the background, depending on the filter (Figure 1). This large scale radial twilight flat-field signature, a purely additive pattern at that point of the detrending process, is intentionally left untouched in the Elixir processed data for distribution to users since standard stacking and photometric extraction software for point sources oriented photometric science effectively handle internal sky correction through a local estimate of the background from the image itself (Bertin et al., 1996 & 2002).

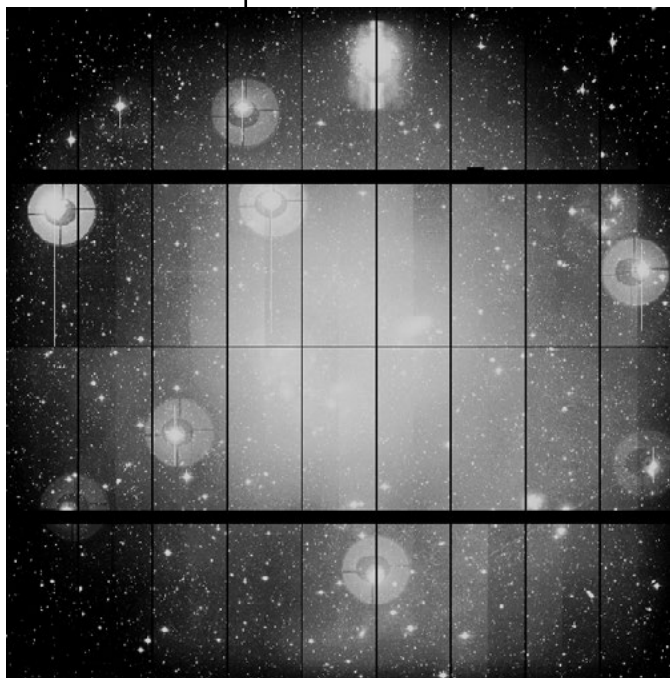

Figure 1

Typical Elixir detrended image exhibiting a radially structured background originating from scattered lights in the instrument optics and data processing in order to achieve a uniform photometric zero-point.

Challenges in extended object photometry

Since scattered light varies appreciably on spatial scales of several tens of arcseconds, the approach of subtracting a local background fails if the objects of interest extend over comparable or larger scales. Additionally, while a master Elixir flat-field per MegaCam observing run for a given filter carries the same radial trend for all processed images, there is also an effect slowly evolving from exposure to exposure due to nighttime sky brightness temporal variation at the percent level on time scales of approximately one hour, depending on the filter used (more stable towards the blue). Therefore, building a scattered light model from images taken more than a few hours from one another (for instance images taken through the night or within an observing run) fails to properly characterize the variable component of the background, leaving peak-to-peak residuals at the 5 to 10% level of the sky. Clearly this falls short, by more than an order of magnitude, of providing precision photometry for extended sources.

Since the problem is the subtraction of an additive, time-variable background, it is natural to turn to techniques

used in the near and far infrared astronomy for a solution, i.e. regularly imaging reference regions relatively free of extended astronomical sources in order to build a background model to be subtracted from the science field. Early investigations in the context of the Elixir effort were conducted between 2004 and 2006 at CFHT using g' MegaCam observations of the Messier 81 group. This study demonstrated that with the proper observing strategy coupled to a custom data processing, one can achieve extremely faint surface brightness and deliver quality photometry on astronomical sources of angular scales that can exceed the one degree field of the view of the camera. Figure 2 shows the 4 square degrees Messier 81 field processed with a basic early version of Elixir-LSB in the g' band: the faintest features (dominated by galactic cirrus in this case) reach 28.5 magnitude per square arcsecond for a 36 minutes integration. This study also demonstrated that by restoring the true flat sky background, stitching seamlessly MegaCam images while preserving photometry of extended objects was possible. Due to higher Elixir priorities this effort remained anecdotal until the approval, in 2008, of the "Next Generation Virgo Survey" (NGVS, Ferrarese et al. 2012), a Large Program that was allocated over 800 hours with MegaCam, spread over 4 years. The NGVS made the development of Elixir-LSB into a full fledged pipeline optimized for all filters a priority, since the study of Virgo cluster galaxies, many of which extend on scales that exceed several arcminutes, and of the diffuse web of filaments and streams that permeate the intracluster medium, requires the photometric precision that only Elixir-LSB can deliver.

NGVS observing strategy

Unlike the case of infrared imaging, in the optical the signal is dominated by astronomical sources: in the case of MegaCam, the sky background level is faint enough for a multitude of faint stars and distant galaxies to be detectable on a few minutes long exposure in any filter. Background frames must therefore be built by median-averaging a reasonable number of highly dithered exposures in order to remove real astronomical objects which, if left in the background frames, would obviously contaminate the science images to be corrected. While the Messier 81 investigation allowed the luxury of sampling "empty" sky regions a couple of degrees away from the group, the cost in observing overheads was large as only a fraction of the time was spent on the scientific target. Fortunately, even for such rich cluster as Virgo, the very few largest galaxies do not exceed 50 arcminutes in diameter, slightly less than the MegaCam one square degree field of view. Any field from the 104 square degrees contiguous survey area (Figure 3) itself can be included in an observing sequence to characterize the scattered light component and natural sky brightness variations. Such sequence must be observed within a period not exceeding the timeframe over which the nighttime sky induced changes on the scattered light go over one percent. This amounts to approximately one hour to achieve the levels required for the NGVS, while at least six fields must be median-combined to ensure that real objects (small and large) are removed in the process (a given sequence should however include at most one field with an extended galaxy or very bright star). All this allows maximizing exposure times to minimize readout and pointing overheads.

The NGVS science requirements necessitate fairly long integrations per MegaCam pointing: $u^*=1.8\text{hr}$, $g^*=0.9\text{hr}$, $r^*=1.4\text{hr}$, $i^*=0.6\text{hr}$, $z^*=1.3\text{hr}$. These integrations must be split in several dithered exposures ($u^*=11 \times 582\text{s}$, $g^*=5 \times 634\text{s}$, $r^*=7 \times 687\text{s}$, $i^*=5 \times 411\text{s}$, $z^*=8 \times 550\text{s}$), spread within a standard 3' arcminutes wide dithering pattern, to avoid saturating the objects of interest while at the same time enabling the rejection of cosmic rays and bad-pixels, and the recovery of the mosaic gaps when stacking data. A strategy was devised to serve both the point source and extended source requirements: due to the need of observing 6 to 7 different NGVS fields within the 1 hour window, in a significant departure from the canonical MegaCam data acquisition procedure, the NGVS does not acquire all exposures within a given dithering pattern as part of an uninterrupted sequence. Rather, a step-dither procedure is adopted: in each filter, a single exposure (corresponding to a given position in the dithering pattern) is acquired for each of 6 to 7 separate fields before a second series of exposures (corresponding to the following position in the dithering pattern) is obtained for the same fields. The sequence is repeated until all pointings in the dithering pattern are acquired for each field. In other words, the NGVS step-dithering procedure can

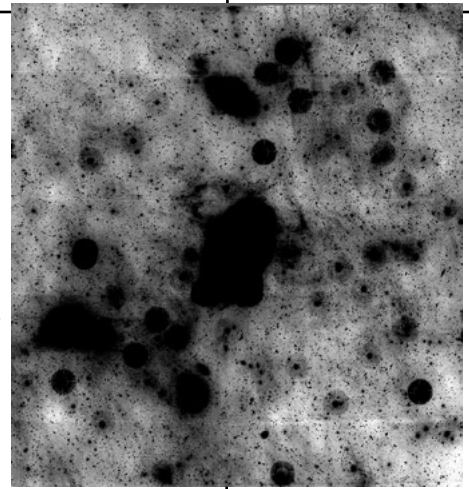
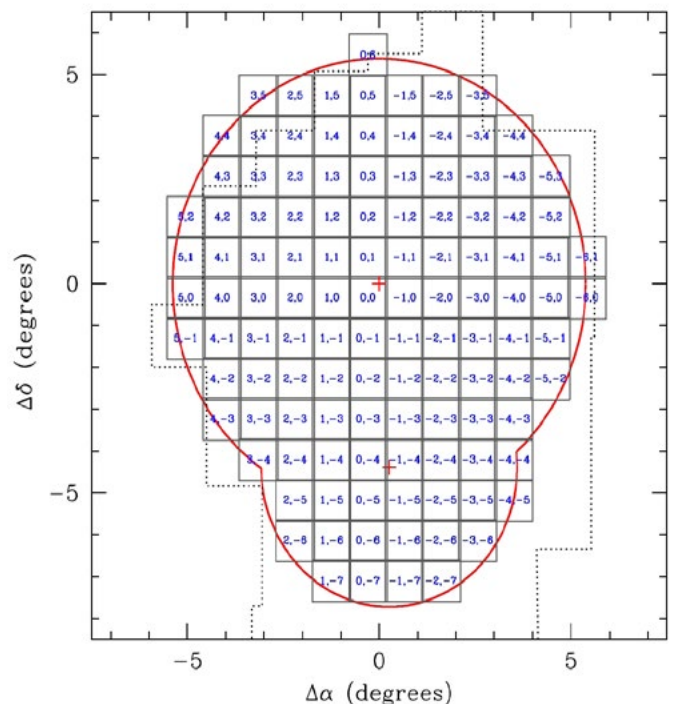

Figure 2

A two by two mosaic of MegaCam pointings (4 square degrees) on the Messier 81 group. Galactic cirrus dominate the background. The detection limit reaches 28.5 magnitude per square arcsecond.

Figure 3

The NGVS survey footprint: 117 MegaCam pointings lead to a 104 square degrees sky coverage once overlaps are accounted for.



be thought of as a dithering pattern applied to a group of fields, rather than to a single field. The fields that are part of a group do not need to be contiguous in space (although they generally are, to minimize telescope slewing time). The only requirement for the procedure is that a minimum of six to seven consecutive exposures must be acquired in an uninterrupted sequence. However, there is no upper limit to the number of exposures that can be taken in a single sequence, nor on the time elapsed between successive sequences of 7 exposures on the same field group in any given filter. It follows that for any given filter, images of a single field are often obtained days, weeks or, in extreme cases, even months apart. Because of the strict observing constraints required for the NGVS, we found that this has no impact on the consistency of the image quality and photometric accuracy between exposures belonging to a single field. This new observing mode has been first implemented for the NGVS in the CFHT queued service observing (QSO) system and is known as a “Target Group” observation.

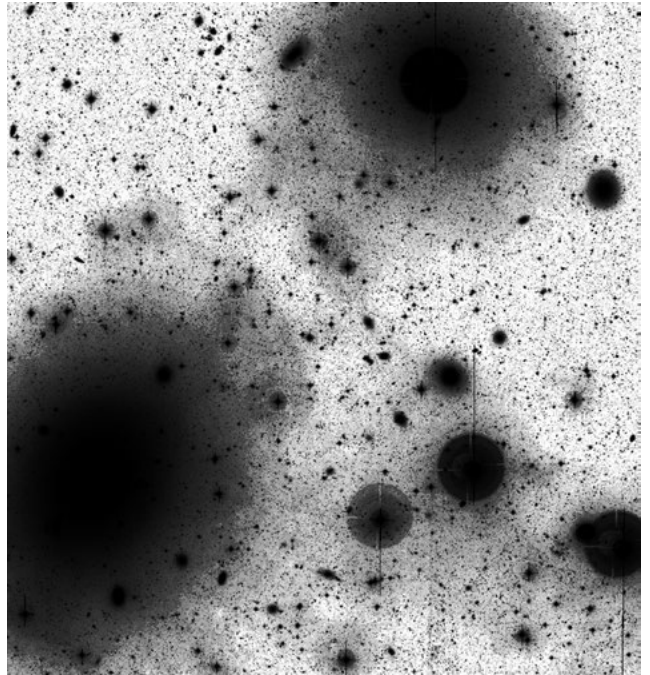

Figure 4 - Elixir-LSB image of the NGVS-1-4 pointing in g' , including Messier 49 in its lower left corner. The large object at the top results from a very bright star ($V=6$) reflections in the optics. The fainter features seen on this image (e.g. shells) reach the 29th magnitude per square arcsecond.

Elixir-LSB processing

Following the first traditional step through Elixir which delivers a photometrically flat and calibrated image, the NGVS exposures are then pushed through the second reduction pipeline, Elixir-LSB, to specifically correct for contamination by scattered light, as discussed above, and restore the true uniform sky background per image through a pure subtraction process that leaves the uniform photometry produced by Elixir untouched. The Elixir-LSB pipeline was optimized specifically for the NGVS, although it can be applied to any MegaCam data that adopts the NGVS step-dither procedure or other smaller dithering variations such as scientific targets that cover only a fraction of the MegaCam field of view (see an application of the technique in Duc et al. 2011).

Elixir-LSB produces a “scattered light” image by combining, after applying some optimal filtering and scaling factor based on individual sky levels, frames of different fields taken as part of an uninterrupted observing sequence (a target group). An optimized sigma clipping algorithm is applied when combining frames, and the resulting image is then median-filtered and gaussian-smoothed before being rescaled and subtracted from each of the individual frames. The key is to derive a sky correction map unaffected by astronomical sources even with as few as the 6 to 7 input images. Extreme care was given to control the technique through its development phases by testing in particular the extraction of major-axis surface brightness profiles in the NGVS down

Figure 5

Left:
Isophotes modelling for Messier 49 based on a mosaic of four NGVS pointings (4 square degrees).

Right:
residuals from the model subtraction showing shells and streams.

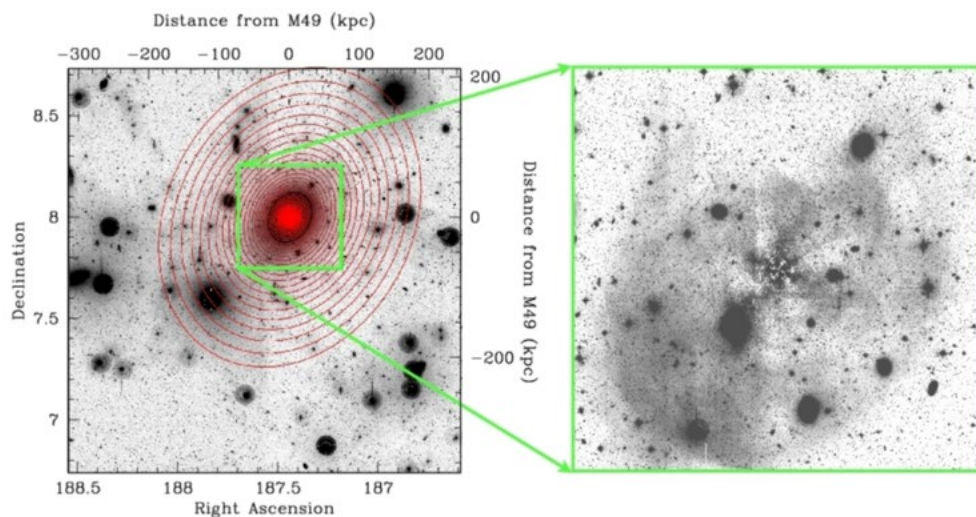

to extreme levels thanks to the integration over an entire galaxy and compare results to the literature (Figures 4, 5, and 6). Typical peak-to-peak residuals in the final scattered-light subtracted images are 0.2% of the sky background in all filters (with excursions of up to 0.5%, but affecting only a small fraction of the mosaic as a result of too many extended objects falling on the same location of the field of view in the input images), allowing the recovery of features with a surface brightness almost 7 magnitudes fainter than the sky background. For a typical dark sky brightness above Mauna Kea, this leads to the following limits in magnitudes per square arcsecond: $u^*=29.3$, $g'=28.9$, $r'=28.3$, $i'=27.4$, $z'=26.1$.

The fundamental limitations to reaching even fainter limits stem from crowding in individual exposures and natural variations in the sky background during the sequence. In z' , for which the defringing is not applied intentionally in Elixir for the NGVS data, an optimized smoothing scale applied to the combined image allows an improved fringing correction over what is achieved by the Elixir pipeline all the while also addressing the main issue. The processing pipeline Elixir-LSB is significantly more complicated than described here and will be discussed in detail in the NGVS Paper II (Cuillandre et al. in preparation).

Figure 7 - Complete Elixir-LSB mosaic of the NGVS in the g' band based on three years of data gathering (a total of 103 hours of validated observing time). Messier 87 lies at the center and four $V=5$ stars are easily spotted on the outer survey area. The Elixir-LSB stitching quality degrades around these stars due to the intense light contamination that can not be modeled.

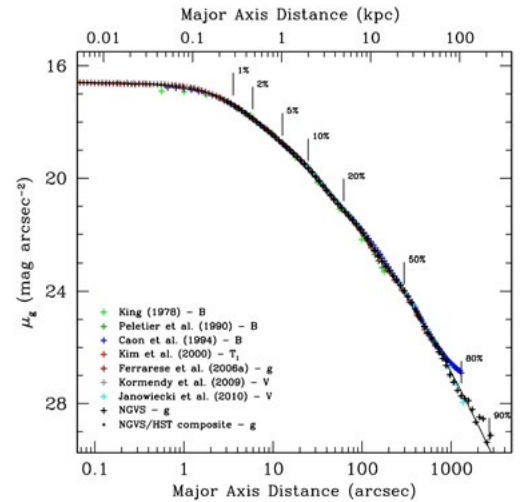
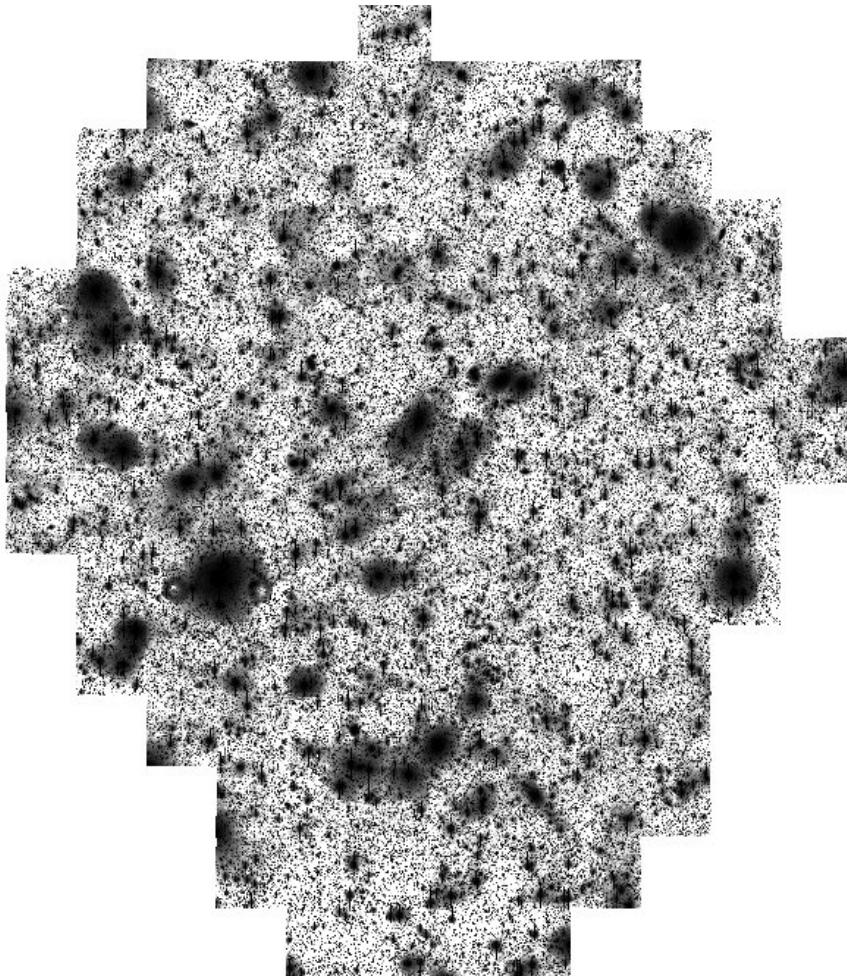

Figure 6

Profile fitting and comparison with the literature. The log scale can be deceptive: the gain brought by the NGVS actually doubles the known extension of the galaxy.

References

Magnier E., Cuillandre J.-C., “The Elixir System: Data Characterization and Calibration at the Canada-France-Hawaii Telescope”, 2004, PASP, 116, 449M

Astier P., Guy J., Regnault N., Pain R., and 34 co-authors, “The Supernova Legacy Survey: measurement from the first year data set”, 2006, A&A, 447, 31

Regnault N., Conley A., Guy J., and 13 co-authors, “Photometric calibration of the Supernova Legacy Survey fields”, 2009, A&A, 506, 999

Bertin E., Arnouts S., “SExtractor: Software for source extraction.”, 1996, A&AS, 117, 393

Bertin E., Mellier Y., Radovich M., Missonnier G., Didelon P., Morin B., “The TERAPIX Pipeline”, 2002, ASPC, 281, 228

Ferrarese L., Coté P., Cuillandre J.-C., and 52 co-authors, “NGVS. I. Introduction to the survey”, 2012, AJ, submitted

Duc P.-A., Cuillandre J.-C., Serra P., and 24 co-authors, “The ATLAS3D project - IX. The merger origin of a fast- and a slow-rotating early-type galaxy revealed with deep optical imaging: first results”, 2011, MNRAS, 417, 863

Observation of Mercury Exosphere

A. Doressoundiram¹ and F. Leblanc²

¹ Observatoire de Paris, Meudon, France ² LATMOS, Paris, France

Objectives

The objectives of this program were to obtain information on the spatial distribution of the Na/K ratio in Mercury's exosphere with respect to Mercury's orbital position. An observation was obtained in 2006 by ESPaDOnS/CFHT. Its result was to provide the first spatially resolved mapping of the Na/K distribution in Mercury's exosphere (Doressoundiram et al. 2010; Leblanc and Doressoundiram 20110). We proposed to complete this first mapping by a second one obtained at a different orbital position of Mercury than during this first mapping.

The image acquisition of the exosphere at high spectral resolution has no equivalent on board the MESSENGER probe now in orbit around Mercury, nor on Earth today. Continuing these observations allow us to make simultaneous observations with MESSENGER and preparing for the mission Bepi Colombo.

Figure 1

Spectra in kilo-Rayleigh/Angstrom (kR/Å) with respect to wavelength λ in Angstrom (Å) measured on the 06/19/2006 with the fiber hole centered on Mercury's apparent disk. Dark line: measured signal. Orange line: solar analogue. Red line: asteroid measurement. Blue vertical line: emission wavelength of Mercury's exosphere (using ephemerides of JPL-Horizon to calculate the Doppler shift).

Top panel: Na D1 and D2 exospheric emission lines.

Bottom panel: K D1 exospheric emission line (Doressoundiram et al. 2010).

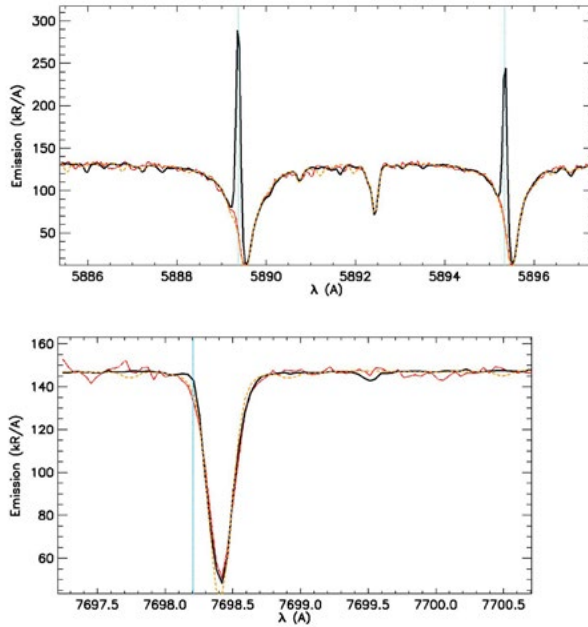

In 2006, we used two telescopes to observe Mercury's exosphere: the telescope NTT using the instrument EMMI and the CFHT using ESPaDOnS. From these observations, we clearly identify sodium and potassium species (Doressoundiram et al. 2010) as shown in Figure 1 in the case of ESPaDOnS observations.

These observations allow us to point out, for the first time, the importance of the spatial distribution of both exospheric species (Figure 2). In another way, we pointed out that both species have their own exospheric spatial distribution and that part of the origin of the unusual Na/K ratio was associated to these differences. We later compare these measurements with the results of simulation and confirmed these conclusions (Leblanc and Doressoundiram 20110).

As shown in Figure 2, ESPaDOnS observations allow us to point out the main characteristics of the Na/K ratio, namely: - a minimum at subsolar point related to the less extended nature of the K exosphere with respect to the Na exosphere - an increase of the

Na/K ratio in the anti-solar direction related to the effect of the solar pressure and solar ionization on the respective distributions of the Na and K atoms.

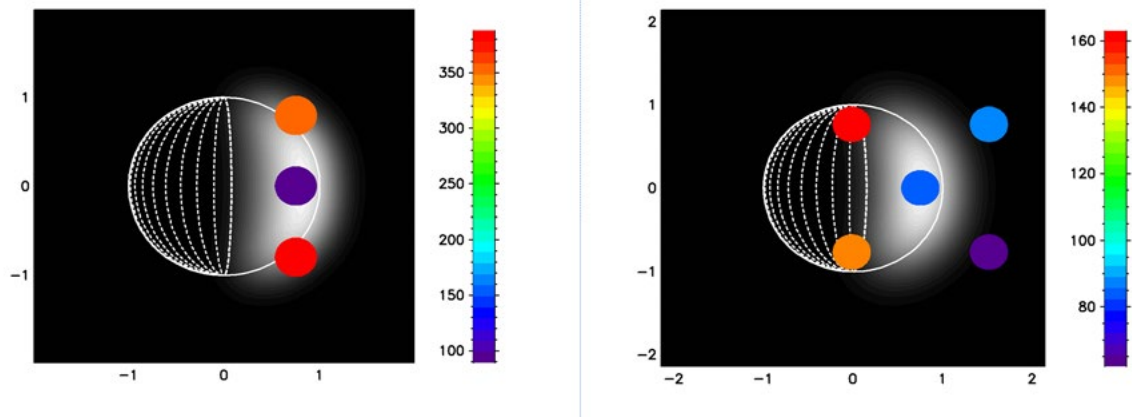

Figure 2 - Na/K ratio measured by ESPaDOnS/CFHT. The different positions are deduced from the approximate position of the hole on a screen control during the observations (estimated uncertainty on the exact position, few tens of a Mercury radius). Mercury's disk is represented by the solid white line whereas the nightside corresponds to the part of the disk with dashed lines. We have also plotted Hapke reflectivity map calculated for the nominal seeing value and phase angle of our observation. Left panel: 06/17/2006. Right panel: 06/19/2006 (from Doressoundiram et al. 2010).

In Leblanc and Doressoundiram (20110), we also highlighted that the only useful data set for analysis was the one from CFHT because of its much higher spatial resolution than using EMMI/NTT. We showed that the main source of information on the global Na/K ratio in Mercury’s exosphere could be obtained in the region close to the subsolar point. Such information can be retrieved only if good signal/noise and spatial resolution can be obtained at various positions in Mercury’s exosphere. So far, only ESPaDOnS/CFHT did provide such properties (we tried to observe sodium/potassium ratio with EMMI/NTT, THEMIS/Canaries and TNG/Canaries without good results).

Results

We obtained observations time between the 7th and 15th of July 2011 on the evening of the 8th, 9th, 10th, 12th, 13th and 15th. The typical sequence of observations is composed of observations at positions 1,7,1,2,3,4,5,6,1,7 with 7 corresponding to a position few tens of arcseconds from Mercury (sky observations). The meaning of each position is displayed in Figure 3.

The observations performed during July 2011 run were done during relatively poor conditions with high humidity (Table 1). We performed a set of complementary observations in order to be able to subtract the telluric lines in Mercury observations spectra and the sky of Mercury. Moreover, in order to extract the exospheric lines, we performed observations of solar analog star and of an asteroid. We also subtracted the telluric lines in the spectrum of the asteroid when these telluric lines could be observed.

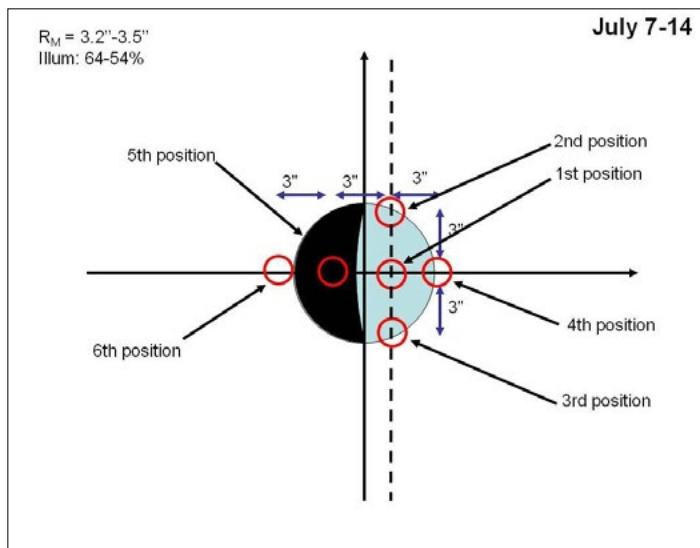

Figure 3
Sequences of observations performed during Mercury’s exosphere observations in July 2011

UT Date	Type of observation	Humidity (%)	Mercury (nb of obs)	Sky of Mercury (nb of obs)	Telluric lines of Mercury (nb of obs)	Sky of telluric lines (nb of obs)	Solar Analog (nb of obs)	Sky solar analog (nb of obs)	Asteroid (nb of obs)	Telluric lines of Asteroid (nb of obs)
July, 8th 2011	Spectroscopy	78	8	2	0	0	1	0	2	0
July, 9th 2011	Spectroscopy	15	17	5	30	0	1	1	2	0
July, 10th 2011	Polarimetry	7	25	7	0	0	0	0	0	0
July 11th, 2011	Spectroscopy	100	No observation clouds							
July, 12th 2011	No observation									
July, 13th 2011	Spectroscopy	5	16	4	18	6	1	1	4	2
July 14th 2011	No observation									
July, 15th 2011	Spectroscopy	-	8	2	9	3	0	0	0	0

Table 1 Observations realized during July 2011 run of Mercury’s exosphere. Sky of Mercury were performed pointing 630 arcseconds away from Mercury, the telluric lines of Mercury were realized pointing Alpha Leo, the solar analog was chosen to be Landolt, the Asteroid was Vesta and the telluric lines of the asteroid were characterized observing Eps Caps.

Unfortunately, we were not able to identify any exospheric emission with the exception of the Na emission lines (Figure 4). Examples of spectra obtained around expected exospheric lines are displayed in Figure 5.

Conclusions

The conditions of observation during July 2011 were too humid to be favorable for the detection of the exospheric lines. Moreover, Mercury’s position during this set of observation was not optimal for exospheric detection (true anomaly angle around 140°) that is at a time during which the heliocentric Doppler shift of Mercury is small and the exospheric lines are deep within the solar lines and more difficult to detect. Orbital period around a true anomaly angle of 90° are clearly more favorable for such detection.

Figure 4 - Left panel: measured spectrum around the Na D1 and D2 emission lines of Mercury's exosphere (positions of the red dashed line) in black solid line at position 1 of Figure 3. The green line is the asteroid spectrum and the blue line is the solar analog. Right panel: set of observations obtained at position 4 of Figure 3 during July 2011 run.

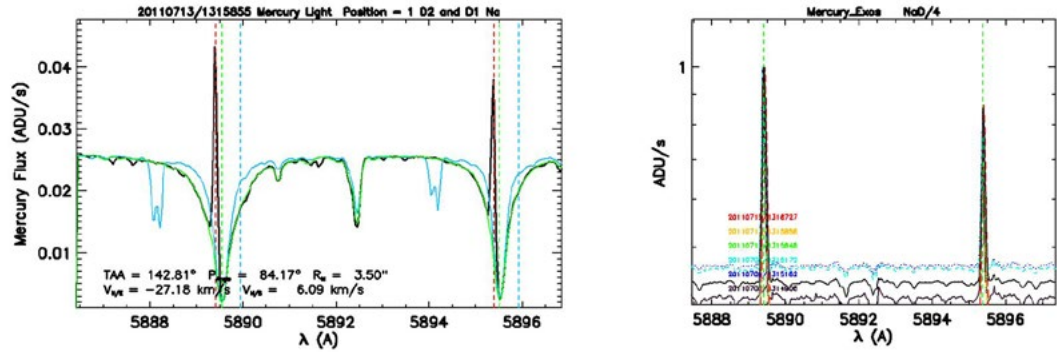
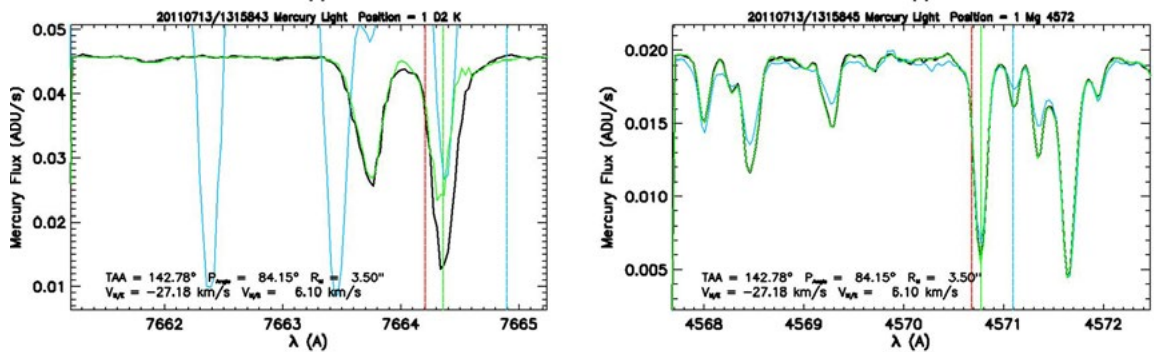

Figure 5 - Examples of spectrum obtained at position 1 (Figure 3) around Al 3961 Å (left upper panel), Ca 4227 Å (right upper panel), K D2 line (left lower panel), Mg 4572 Å (right lower panel). The red vertical line indicates the expected position of the exospheric line. The green line is the solar analog spectrum as calculated from the Asteroid observation and the blue line from the star. Telluric lines were subtracted from Mercury spectrum, from Asteroid spectrum as well as the sky emission.



References

- Doressoundiram A., F. Leblanc, C. Foellmi, Gicquel, A., G. Cremonese, F. Donati, and C. Veillet, Spatial variations of the sodium/potassium ratio in Mercury's exosphere uncovered by high-resolution spectroscopy, *Icarus*, 207, 1-8, 2010.
- Leblanc F. and Doressoundiram A., Mercury Exosphere II The sodium/potassium ratio, *Icarus*, Accepted, 2010211, 10-20, 2011.

An unusual view: CFHT observing in daylight



Observations of Venus with ESPaDOnS are done in full daylight. The picture on the left shows the open dome, with the wind screen and shutter providing as much shade as possible in the dome. In such a mode, observations are conducted from the summit. In order to prevent the sun to hit any sensitive area of the telescope or the equipment inside the dome, help is required

from the PI and his team who provide a continuous human presence inside the dome.

On the right, Venus is seen on the ESPaDOnS guider's window with the two holes for the "sky" and "star" fibers, looking at different areas of Venus atmosphere.

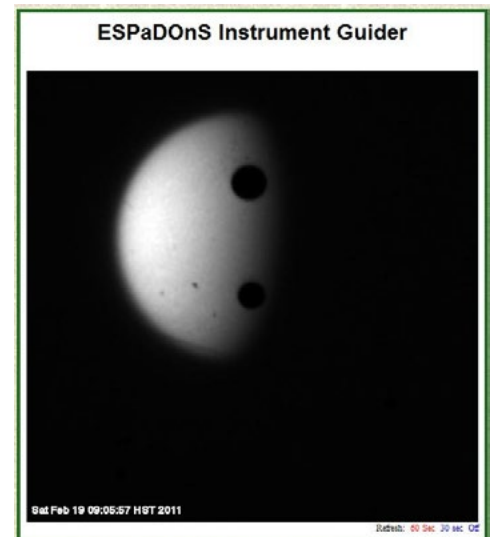

Venus high atmosphere from Earth and Space

T. Widemann - Paris Obs.

Venus is one of the most intriguing bodies in the Solar System. It is almost the same size as the Earth and apparently has a similar bulk composition – yet it has ended up with an extreme climate with surface pressure of 90 bar and surface temperatures of 740 K. Venus’ middle atmosphere (60-120 km, also known as the mesosphere) acts as a transition region between the lower atmosphere (from the surface to within the cloud layer near 60 km), where the circulation is mainly parallel to the equator, and the upper thermosphere (above 120 km), where the wind pattern is mostly driven by diurnal pressure contrasts towards the night side hemisphere. Planet Venus is also one of the most difficult to observe – close to twilight, it represents a challenge for use of major optical facilities and their instrumentation and since 2007 CFHT has outstandingly pioneered this effort (Widemann et al., 2008).

From space, Venus’ atmospheric circulation at an altitude of 70 km (as well as near 50 km on the nightside) is being measured from the tracking of small-scale cloud structures by the VIRTIS-M and VMC instruments. However, winds derived in this manner do not necessarily reflect the true circulation. They may instead represent the phase speed of a condensation wave, as in the case of Earth’s orographic clouds which remain fixed to mountain tops regardless of the wind velocity, while cloud particles are moving at the horizontal wind velocity. In addition, cloud tracking is not able to measure wind fields above cloud level, where wind inferences have to rely on indirect hypothesis such as cyclostrophic equilibrium. CFHT’s ESPaDOnS can measure the wind field on the day side using Doppler velocimetry of the solar Fraunhofer lines in sunlight scattered by the cloud tops at an accuracy of 4-5 m/s, a technique allowed by the high resolving power and spectral stability of ESPaDOnS used in photometry mode. In 2011, Venus has been observed using a semi-automated QSO mode during a three-day run on February 19-21 2011, synchronized for the first time with European Space Agency’s Venus-Express (VEx) operations at ESAC. Scanning sequences over the South, day side hemisphere were done as planned, in good seeing conditions. 123 individual velocity measurements were acquired simultaneously with Venus Express’ ascending branch observations of the same region of the Venus atmosphere (Fig. 2).

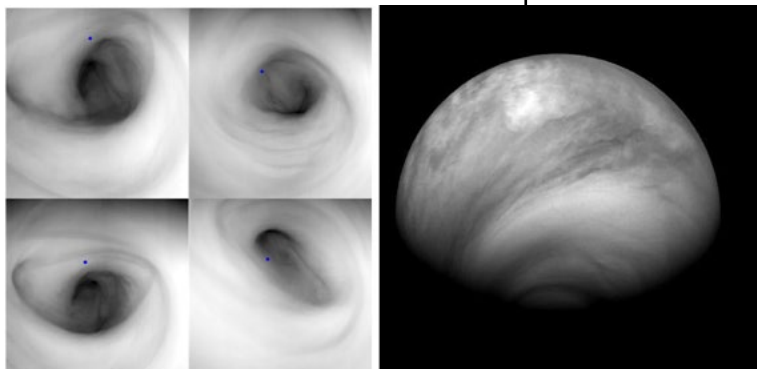
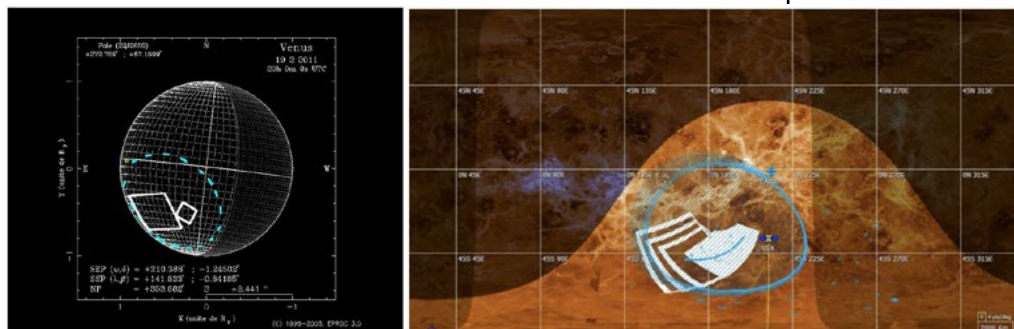

Figure 1 - l The polar region of Venus, at a wavelength of 3.8 microns, denotes the motion of the atmospheric vortex around a centre of rotation. The vortex center is found to be displaced on average by about 300 km from the South Pole (marked with a blue dot) and rotating around it in an unexplained precession movement (ESA/VIRTIS-VenusX/INAF-IASF/LESIA-Obs. Paris).

r - General view from below the south pole of cloud ultraviolet contrasts. Image obtained by the Venus Monitoring Camera. Venus Express measures wind fields at the cloud-tops by tracing cloud features. However, there is continuing debate as to whether the velocities measured represent the true speed of the air or whether they represent the phase speed of atmospheric waves breaking in the clouds. Ground-based Doppler velocimetry measures the true speed of the cloud tops. Spectroscopic observations of Venus from previous work at CFHT have demonstrated that winds can be measured by Doppler with a few m/s accuracy from the ground (Widemann et al., 2008) (Credit: ESA/ MPS/DLR/IDA).

Once the measurements of wind components have been validated, it will be possible to construct further quantities to diagnose the atmospheric circulation, such as meridional and momentum fluxes or, from the best quality results, the potential vorticity. The accumulation of wind and temperature measurements over the duration of the mission has already provided a wealth of data, covering the whole of the southern hemisphere, that should allow these fluxes to be computed with sufficient precision. This will be a robust diagnostic of the latitudinal exchanges of heat and momentum at the cloud tops, and it will also be used to benchmark and optimize the Venus global circulation models.

Figure 2 - Planet Venus has been observed (l.) using a semi-automated QSO mode during a three-day run on February 19-21 2011 synchronized for the first time with European Space Agency’s Venus-Express (VEx) operations of VMC and VIRTIS instruments performing cloud tracking (r., orbits 1766-1767). Comparing the two techniques applied to the same airmass allow to discriminate the actual atmospheric Doppler circulation from the motion of cloud structures.



Reference Widemann, T., Lellouch, E., and Donati, J.-F., 2008. Venus Doppler winds at cloud tops observed with ESPaDOnS at CFHT. Planetary and Space Science, Volume 56, Issue 10, p. 1320-1334.

How hot is it under the dome?

Karun Thanjavur

CFHT is located at the best site for image quality (IQ) on the summit of Mauna Kea, averaging about $0''.3$ or better as assessed by site monitoring tests. The key factor to benchmark the performance of the observatory, however, is the delivered IQ as measured directly on observed images. For CFHT, based on several years of CFH12K and MegaCam imaging, it has been argued that the free atmosphere IQ is increased by $\sim 0''.2$ to $0''.3$, leading to a median seeing of $0''.6$ or larger, a significant degradation from what is theoretically achievable.

Even though various factors contribute to this loss in the image quality, a significant contribution arises from dome seeing, which is due to thermal instability and consequent turbulence in the air within the dome of the observatory. Such thermal instability may arise either from heat injection into the dome environment or from heat losses leading to the dome air temperature being below that of the surroundings. The aim of our work described in this article is to obtain a thermal assay of the dome environment in order to characterize the various factors which affect dome seeing, and thus explore ways of minimizing the thermal instability and mitigate IQ degradation. This work is being carried out under the overall banner of the IQ improvement initiative at CFHT, in parallel and in close collaboration with the dome venting project at CFHT slated for implementation in 2013.

Heat ingress occurs from various sources, such as running equipment within the dome, heat conducted and dissipated by the telescope structure, and even by the structure of the observatory itself. In order to obtain a census of these sources and their relative contribution to the heat input to the dome, we used two approaches, first an overflight of the observatory at night to image the building and the surroundings using a handheld infrared camera, followed by more detailed thermal imaging of the various equipment in the dome using the same IR camera.

The overflight was done on the night of 22 October 2010 around 21h in a Cessna four-seater plane. Several passes of the area were done from different directions. The IR camera used for imaging was FLIR SC620, and was calibrated to dynamically scale and record the full thermal range of each image. Software supplied by the camera manufacturer was used to extract and calibrate these thermal images.

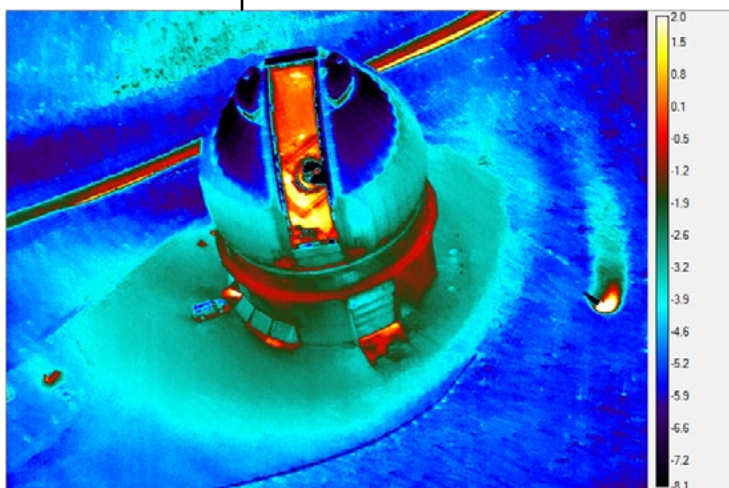

Figure 1

Thermal image of CFHT taken with the IR camera. The view is from the East, and the indicated temperature scale is in degrees celsius.

A sample thermal image of the observatory and the surroundings taken during an overflight from the east, and looking directly down into the dome through the open observing slit, is shown in Fig 1. Using the temperature scale, calibrated in degrees Celsius, shown on the right of the figure, the concrete structures of the observatory building are seen to be $\sim 5\text{C}$ hotter than the surroundings, even after dissipating the heat accumulated during the day to the cold night air. Two other hot spots outside the building are the heat exhaust seen on the right, and an electrical transformer. The paved tarmac in the background follows a similar thermal profile. However, the surrounding ground appears a few degrees colder than the ambient, similar to the temperature of the top of the dome. Even though these surfaces may be radiatively cooling by transfer to the night sky, we surmise that there may also be a partial contribution due to the reflection of the cold night sky on these surfaces as seen in these nIR images.

The true dome skin temperature was measured subsequently using temperature loggers, the results from which are described later in this article. Most striking of all is the dome environment itself, imaged through the slit, which is clearly a few degrees warmer than the surroundings. The floor temperature is equivalent to that of the air from the exhaust vent, while the inner dome skin is ~ 2 to 3 degrees warmer than the ambient. It is noteworthy that the top ring and the upper structures of the telescope match the temperature of the top of the outer dome, indicating radiative cooling as well as the reflection of the night sky. In summary, the thermal pattern of the dome environment is complex with contributions from many factors, of which our aim is to minimize at least the dominant ones.

In order to complete a more detailed quantitative assessment of the heat input from these sources, especially within the dome, we next carried out thermal imaging of individual heat sources using the same IR camera used for the overflights. Fig 2 (right) shows two striking examples of significant heat input to the dome, the thermal image of WIRCam in storage (left), and the PLC units for MegaCam when it is in storage (right). The temperature profile of WIRCam, $\sim 7\text{C}$ warmer than the ambient, is especially significant since this heat input will occur

directly in the main optical path PLCs, subsequent to these thermal imaging, it was realized that these units may be turned off when the instrument is in storage, thus leading to the first corrective action taken to minimize dome seeing.

The thermal images also showed that the floor of the dome, Fig 3 (below left), which is actively

cooled by refrigerant coils during the day, is a few degrees cooler than the telescope structures, as seen by the temperature of the North pier. The image shows a source of heat input along the footpad, whose source is yet to be ascertained. In comparison, the inner dome skin, Fig 3 (below right), is a degree or two warmer than the dome arch girders on which they are supported. This is due to the inner skin being in thermal contact with the warmer air in the dome, while the girders cool to the temperature of the outer dome skin through conductive heat transfer. Given the size of the CFHT dome and the large heat transfer area to the surrounding air, this difference between the inner and outer skins of the dome, also seen in the thermal overflight image shown in Fig 1, is expected to lead to a similar temperature difference in the air column at the imaging slit, resulting in turbulent instability and consequent dome seeing.

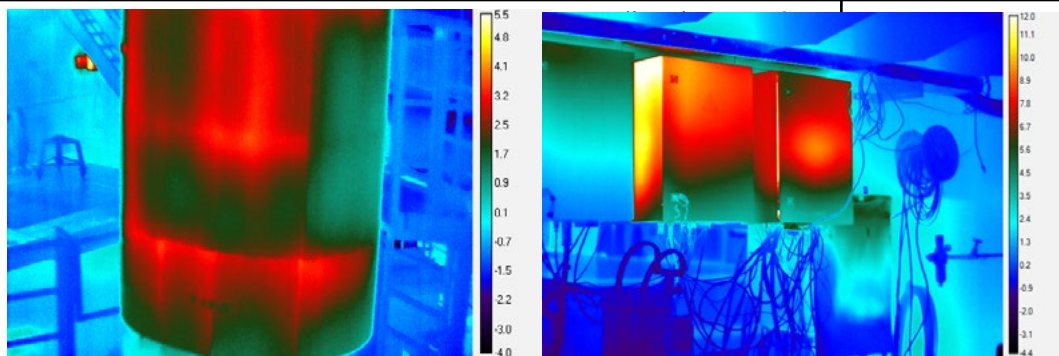

Figure 2
Thermal images of equipment within the dome environment, imaged with the IR camera. On the left is WIRCam in storage, while on the right are the MegaCam PLC units. The color bars indicate temperatures in degrees Celsius, and have been scaled to include the complete dynamic range of temperatures in each image.

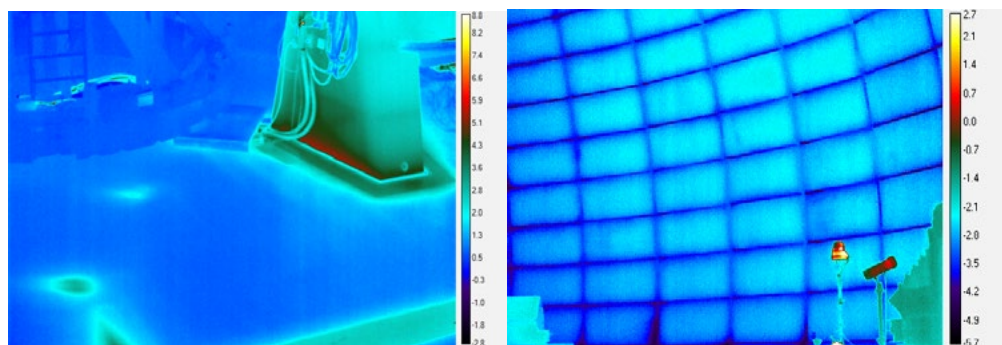

Figure 3 - Thermal images of the dome floor and the inner dome skin. The floor is seen to be a few degrees cooler than the North pier of the telescope. The inner dome skin on the other hand is hotter by a similar margin than the dome arch girders, seen as the rectangular grid work, whose temperatures follow that of the cold outer dome skin via conductive heat transfer.

On a clear night, the night sky is appreciably colder than the ambient, and is nominally assumed to be at -40C. An untreated dome skin would radiate directly to this cold sink, resulting in supercooling and an appreciable temperature difference between the skin surface and the ambient air. We therefore undertook to measure the dome skin temperature at night using button temperature loggers, Fig 4, fixed directly to the metal of the dome skin. For comparison, we also simultaneously measured the night time dome skin temperatures of the Frederick C. Gillett Gemini North Telescope (Gemini, henceforth), and the NASA-IRTF observatories, and thus compare the effectiveness of the different coatings used by these three observatories. The CFHT dome has been painted with the traditional, high adhesive, titanium dioxide (TiO₂) white paint. Gemini uses LowMit, a special aluminum-based, low emissivity paint, while IRTF has a coating of a special 3M aluminum foil.

The off-the-shelf button style temperature loggers, Maxim DS1922L, were programmed to measure and log the dome skin temperature at 3 minute intervals for a period of seven days. The loggers were placed in direct contact with the dome skin with some silicone grease to improve contact, Fig 4 (right), and thus their temperature sensitivity. A piece of foam and a patch of aluminum tape were used to affix the loggers to the dome skin.

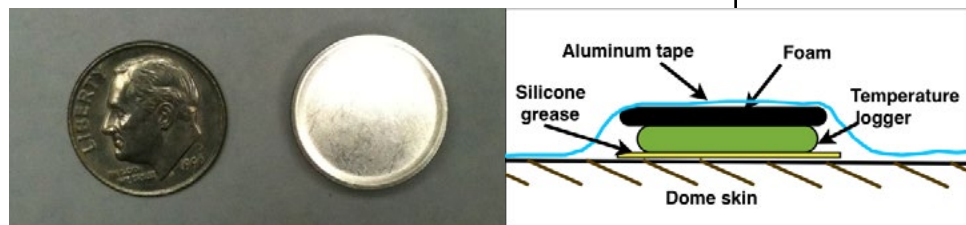

Figure 4
The Maxim DS1922L button type temperature logger used to measure the dome skin temperature, shown compared to a dime for size (left). A cartoon illustrating the mounting of the temperature logger to the dome skin (right).

We used three loggers each for the CFHT and IRTF domes, and two on Gemini due to difficulty of access on the steeply sloping dome at Gemini. The clocks on all the loggers were synchronized prior to installation. The temperature loggers were installed on the afternoon of 17 Feb 2011 and recorded till 24 Feb when the memory storage was filled. Weather data, including wind speed and direction, ambient air temperature (from several locations), relative humidity and cloud cover, were obtained from the CFHT logs. It must be mentioned that the skies were photometric on nights 1, 2 and 4, cloudy with high humidity on 3 and 5, and completely overcast with snow on nights 6 and 7.

We used three loggers each for the CFHT and IRTF domes, and two on Gemini due to difficulty of access on the steeply sloping dome at Gemini. The clocks on all the loggers were synchronized prior to installation. The temperature loggers were installed on the afternoon of 17 Feb 2011 and recorded till 24 Feb when the memory storage was filled. Weather data, including wind speed and direction, ambient air temperature (from several locations), relative humidity and cloud cover, were obtained from the CFHT logs. It must be mentioned that the skies were photometric on nights 1, 2 and 4, cloudy with high humidity on 3 and 5, and completely overcast with snow on nights 6 and 7.

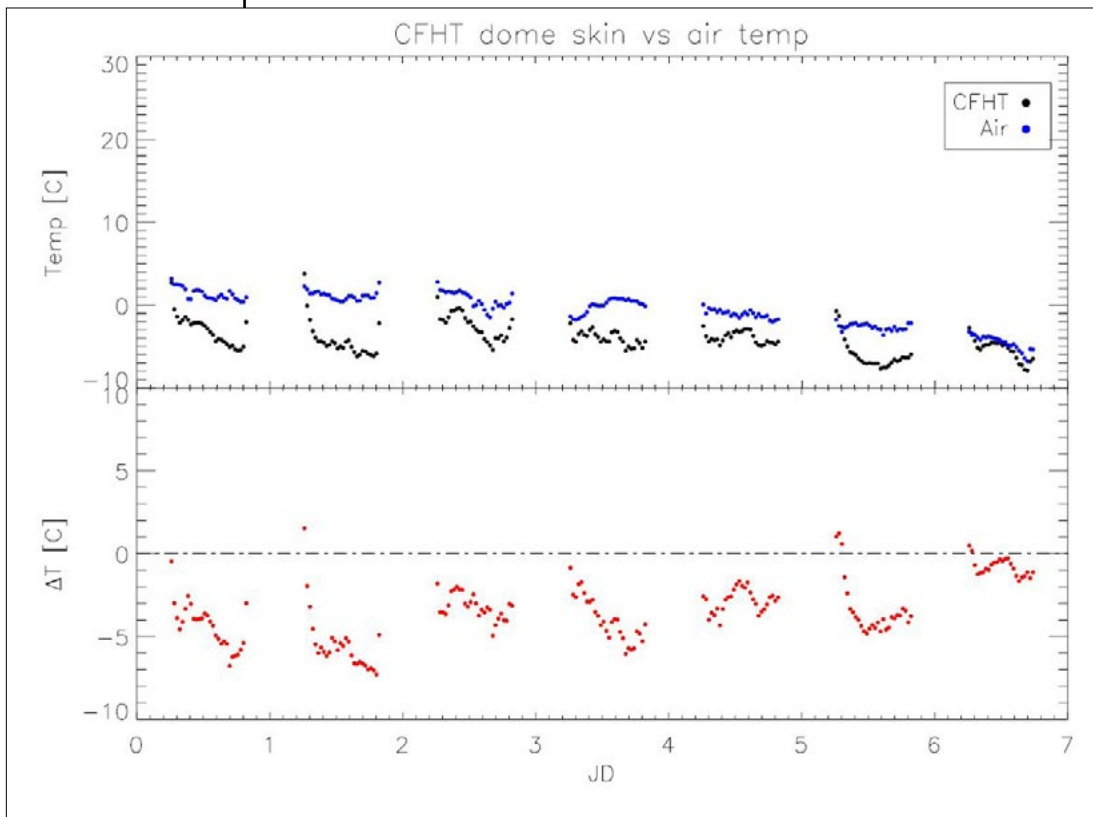

Figure 5

Night time temperature trace of the CFHT dome skin as recorded by the temperature loggers on seven consequent nights. The top panel shows the dome skin and ambient air temperatures, while the lower panel shows their difference.

performance of the Gemini and IRTF dome skins showed that both the LowMit and the aluminum foil cladding performed equally well, with their dome skins closely following the ambient throughout the night. However, the day time temperature of the aluminum foil on IRTF was appreciably higher ($> 20\text{C}$) compared to the Gemini dome, indicating an overall superiority of the LowMit coating.

In conclusion, our work on the thermal assay in the dome environment is ongoing with a more quantitative assessment of the heat input planned using electrical power measurement to various devices highlighted as heat sources by the thermal imaging. These power measurements will help prioritize plans for minimizing this ingress. Regarding the dome skin, plans to repaint the dome with the more effective LowMit have been discussed, realistically following the installation of the dome venting windows next year.

Full results from this study have been accepted for an oral presentation at the upcoming SPIE Astronomical Telescopes and Instrumentation conference to be held 1-6 July 2012 in Amsterdam, The Netherlands.

Even though a full discussion of the interesting results we obtained from this study is beyond the scope of this report, we have included the crucial finding that the CFHT dome is indeed supercooling at night, shown by the temperature traces of the dome skin and the ambient air in Fig 5; the lower panel plots their difference. It is clear that the dome skin is $\sim 5\text{C}$ below the ambient on the clear nights, while there is little difference between the two temperatures under cloudy conditions, especially with snow cover. This is a clear indication that the primary mode of heat loss is radiation to the cold night sky, which occurs only when the skies are photometric; on overcast nights, clouds reflect the radiated heat and thus the dome stabilizes to the ambient temperature. The perfor-

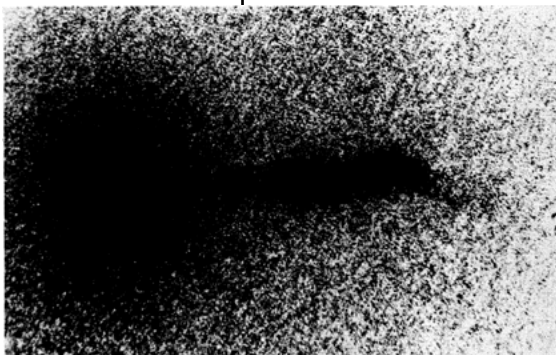

M87

High resolution photographic images of 1 hour exposure with the UV corrector allowed to identify many knots in the jet of M87 and to study its structure (Nieto & Lelievre)

Thirty years ago

THE FIRST FULL YEAR OF SCIENTIFIC OPERATION

During 1981, 71 percent of the nights of the CFHT were allocated to astronomical observing. This may be compared to 38 percent in 1980. Thus 1981 was truly the first year of normal scientific operation when the amount of telescope time used for astronomical research exceeded the one devoted to engineering ... The CFHT telescope is now definitely launched and the scientific results it generates have begun to be noticed in the literature and at meetings. The available CFHT instrumentation during 1981 was essentially limited to direct imagery at the prime focus, to field spectroscopy using “grenses” and to coude spectroscopy with the Reticon detector. Scientists have however been able to put to good advantage the excellence of the site and the performance of the telescope. A number of opportunities unique to the CFHT have already been clearly identified: high resolution imagery (less than 0.5 arc second), very high accuracy spectrophotometry, and high precision radial velocity work (better than 10 meters per second). ... The telescope has now entered its fully productive scientific life. Experience during 1981 has clearly demonstrated the great merits of our facilities. The scientific future of the CFHT telescope appears very bright.

Dome Venting Project

With the strong suspicion that the lack of proper venting of the dome was degrading the outside seeing, it was decided by the end of 2009 to start an in-house project, dome venting, funded using CFHT's Development Fund and aiming at (1) confirming through appropriate studies the value of venting the dome already recognized through MegaCam IQ studies, and (2) designing and implementing vents on the dome.

Since then, much work has been accomplished and 20011 saw the completion of the various tests and studies performed to confirm that dome venting is indeed a good idea. Two main areas were covered: CFD simulations on one side and water and wind tunnel tests on the other side.

CFD simulations

Detailed CFD models were run under an agreement with TMT in which they provided these services in exchange for CFHT seeing statistic.

Vertical cross section of a CFD simulation for the unvented dome with the slit pointed into the wind at azimuth 100 degrees (10 degrees off the wind from the East - 90 degrees). Wind speed is 5 m/s. The solution time given on the figures is the time evolution from the start of the simulation needed for the model to settle into a realistic state. (Actual cpu time is many hours). The color coding has been scaled to highlight air temperature changes associated with flows in and around the telescope enclosure. Input parameters for the various simulations shown here are:

- Upstream temperature profile -6K/km,
- Tref = 276K at ~20m level
- Topography: -10W/m2
- Outer dome skin: Tref -6
- Inner dome skin, floor: Tref -2
- MegaCam cage: Tref +1
- Primary mirror: Tref +3
- Hydrostatic pads: Tref +7
- Observing floor: Tref -2

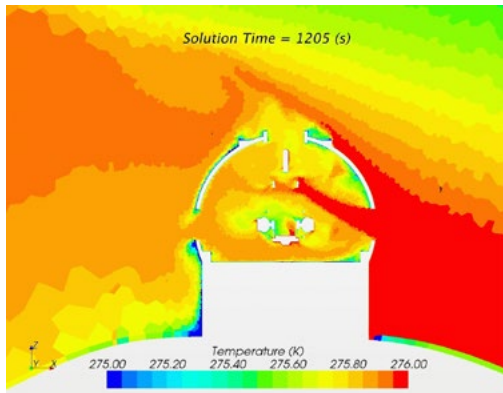

Vented dome, with dome slit pointed 90 degrees from the wind.

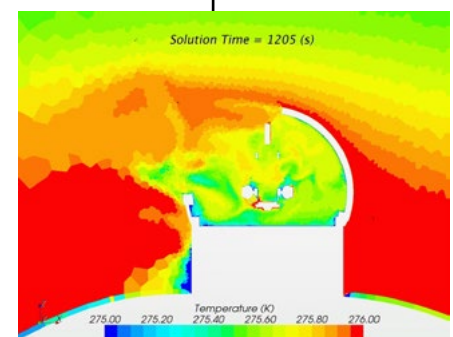
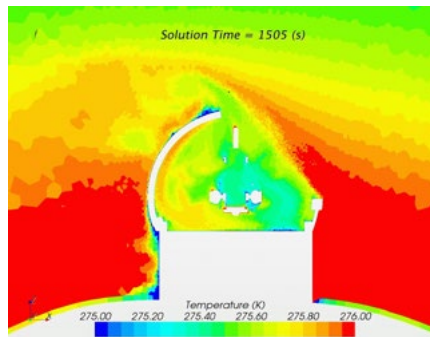

Unvented dome, with dome slit pointed into the wind (left) and downwind (right). Backflow into the dome is evident when pointing downwind.

Vertical cross section of the vented dome with a south pointing slit 90 degrees to the wind is shown on the left. This case had a single 4m wide by 5.5 m high vent directly upwind. Upward flow through the vent impacting the top of the telescope structure suggests the need for some form of flow redirection – in our case starting with internal louvers to direct the flow in a more horizontal direction. (CFD computations and images courtesy of Konstantinos Vogiatzous – NOAO/TMT)

Water and wind tunnel tests

Water tunnel tests and limited wind tunnel tests were conducted by CFHT staff at the University of Washington in March and July, 2011, wind tunnel tests were conducted by ASIAA staff at the National Ocean University of Taiwan in Keelung City north of Taipei. We will concentrate here on the water tunnel tests.

Water tunnel tests were conducted at low Reynolds number (4.6×10^4) using a 1:160 scale model of the telescope, dome, building and the upper 15 m (50 feet) of the summit terrain. The models, built around a set of 20 cm (8 inch) diameter acrylic spheres, were designed and built by CFHT staff and permitted rapid interchange between dome configurations with the dome rotated to any desired azimuth while the model remained im-

mersed. Neutrally buoyant food coloring dyes were injected through probes made of hypodermic needle material. Probes were provided outside the dome and inside the dome at the level of the observing floor and above the primary mirror. Water flow was continuous and at a constant rate from the East for all water tunnel tests.

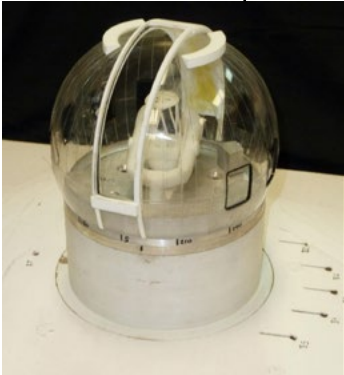

Summit building model

1:160 scale model of the telescope, dome, and building. The dome diameter is 20cm.

Test measurements were devised from simultaneous pairs of video files taken over a wide range of dye probe configurations for dome slit-to-wind angles between 0 and 180 degrees both from the side and while looking vertically down (up at the water tunnel) on the dome. Cameras were synchronized to within roughly 0.2 sec using cross correlation of their respective audio channels. Timing was based on the camera frame rate. A typical frame pairs is shown on the right. Videos were analyzed on a frame-by-frame basis using purpose-written MatLab functions.

One of the information extracted from the analysis of the videos is the dome flushing time constant. It is plotted below as a function of the slit-to-wind angles. Ninety five percent flushing is achieved after 3 time constants. Data points at 135

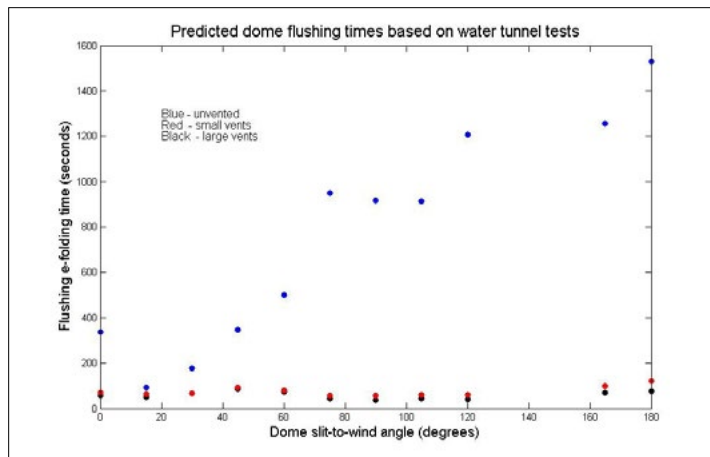
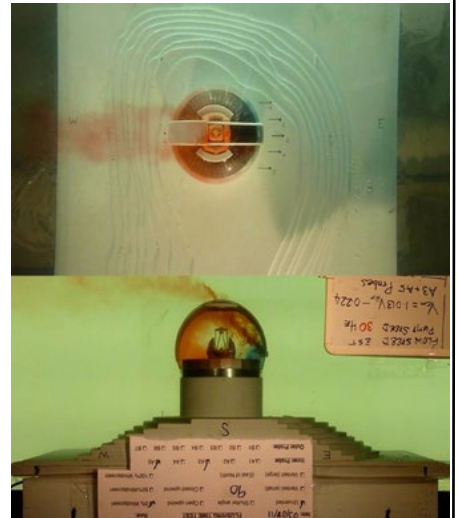

and 150 degrees have been omitted due to difficulties with the data. Up to slit-to-wind angles of about 75 degrees the flushing circulation inside the unvented dome is well organized, but of decreasing efficiency as the dome slit moves off the wind. As the slit's orientation passes to a down wind direction internal flow in the unvented dome becomes much more complex and slower.

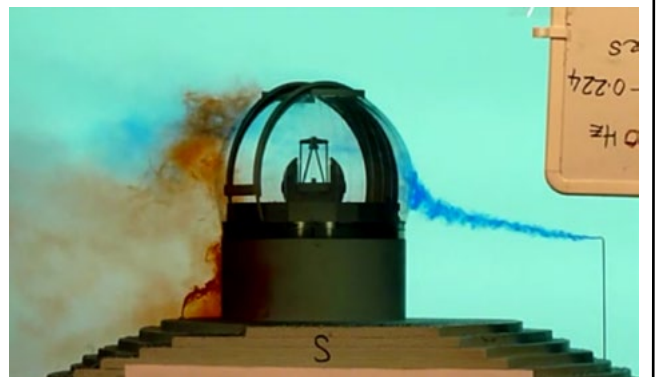

In the images above, red dye has been released from a probe located just above ground level in the lee of the dome, while blue dye released upstream impinges on the dome near the spring line. On Mauna Kea, terrain on the lee side of the building cools radiatively to the sky without the stabilizing influence of strong local air flow. The cold upwelling air can therefore be expected to contribute to facility seeing when observing downwind away from zenith.

Conclusions of the tests and stimulations

- With the slit pointed within 30° of the wind, dome flushing times are not much improved by venting and telescope image quality is near optimal except near zenith.
- Significant reduction in dome flushing times are observed with vents. Flushing time constants, as predicted from water tunnel tests, for the unvented dome grow more or less linearly from 1 minute to half-an-hour for slit-to-wind angles from 0° to 180°, while with vents the flushing time constant remains under 2 minutes for all slit-to-wind orientation, and changed little when reducing vent area by a factor of 1.5 from 32 m² to 22 m² per vent.

- c) Significant internal flow out the top of the dome exists at most slit-to-wind angles, leading to degraded image quality at zenith. This effect implies that any future over-the-top slit shutters should open considerably farther past zenith than does our dome, and in order to open sufficiently the shutter would likely have to stack.
- d) Flow inside both the vented and unvented dome is complex. Nonetheless, water tunnel tests suggest that mixing times are short compared to flushing times. The implication is that all internal dome surfaces at temperatures different from the outer air contribute to dome seeing. Given their long thermal times constants, the dome inner skin, tube structure and cooled observing floor all are likely large contributors to enclosure-induced image blur. The thermal mitigation program will be an essential contributor to dome seeing improvements.
- e) External upwelling of air on the lee side of the building is a likely contributor to degraded images when observing downwind.
- f) Flow entering the upwind vent is naturally jetted upwards toward the top of the telescope due to natural flow around the building and to the upwind slope of the terrain. As a consequence, we plan to have the ability to modulate vent air flow individually at each vent so that the vent located directly upwind can be gated, if need be, to avoid telescope shake.
- g) The horseshoe vortex surrounding the dome building seen in aerial thermal images does not extend vertically beyond the external catwalk and therefore does not contribute to enclosure-generated image blur.
- h) Flushing times expected for the real-world dome are likely to be longer than predicted from water tunnel tests. At the higher Reynolds number (Re) flow experienced at the summit, flow separation on the lee side of the building can be delayed compared to low Re water tunnel tests, and it is in this region of lee side separation that an advantageous pressure drop occurs. However, as CFD models have shown, except when observing directly down wind, the dome arch-girders ‘trip’ the real-world flow and re-introduce an earlier-than-expected flow separation and its accompanying beneficial pressure drop.
- i) Flushing times for dye released at the center of the dome near the primary mirror are longer than for dye released near the observing floor indicating that we might want to consider installing a mirror-cover geometry that is more open to air flow than the current arrangement allows.

Vent preliminary design

The preliminary design proposed in the call for bids has been simplified from the initial design envisioned in late 2010. It is now based on a set of 12 vents, 2m wide and 5.5m high each, to be installed from inside between the vertical webs supporting the dome skin.

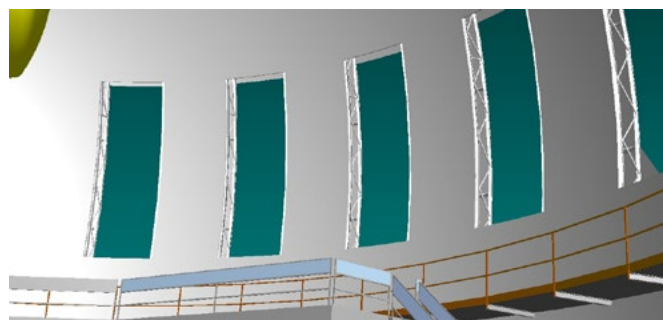
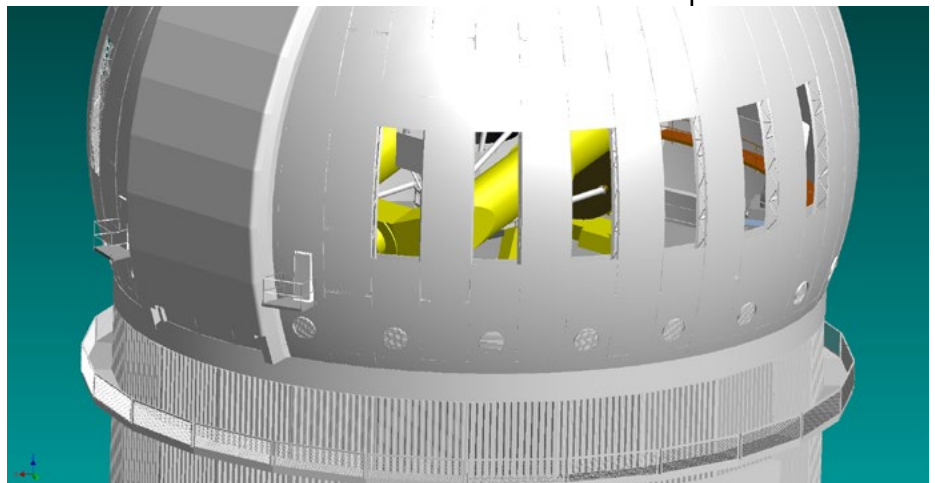
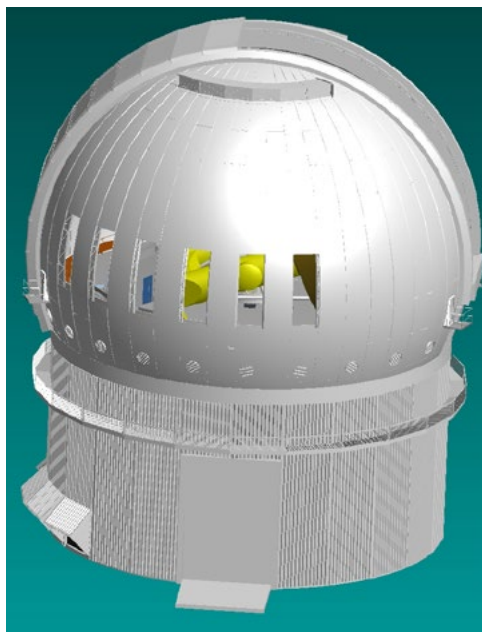

Vent Preliminary Design

A call for bids together with a draft contract form and technical specifications was issued in November, with an on-site pre-bid familiarization visit in early December. Selection of the contractor is scheduled for early 2012.

The dome drives go electric!



Figure 1

Right:

Before: the hydraulic motor with one of its hoses is on the right, horizontally coupled to the gear box.

Left:

After: the gear box has been turned up by 90 degrees, with the electric motor and its new coupling (red) sitting vertically on the gear box.

For more than three decades, our dome rotation has been enabled by three hydraulic motors powered by high pressure oil, pumped faithfully from four floors below by a robust, but not that energy-efficient, hydraulic system. With the observatory in remote operation mode, it was decided to move to a new system more energy-efficient, easily controllable from Waimea, and requiring less maintenance, while mitigating the EPA risks related to oil leaks. Moving to electric drives was considered the best choice. Though not part of the Observatory Automation Project (OAP) per se, the project built on the experience acquired by developing the remote control of the many OAP subsystems.



New electric motors and adapter kits replacing the original hydraulic motors were coupled to the existing gear reduction boxes on each drive unit. No changes were made on the gear boxes or driving friction wheels. The new dome drive system was finished and commissioned on April 28, 2011, without interruption in the night time operations. It has been operating without issue ever since, but for a motor dying from a manufacturing defect while still under warranty.

The heart of the system, controlling the motors, is located on the fourth floor in the old lama room; the electric motor control cabinet can be viewed remotely via a web camera and its status can be monitored remotely for troubleshooting (Fig. 2). The electric drive system parameters are available via the OAP status web page; alerts and warnings keep key staff informed of issues or abnormal system operation. The graphs on Figure 3 shows several parameters that are monitored and plotted on the motor controller information page.

The system includes of new pneumatic actuators on the 5th floor which provide a means to lift the dome drive wheels off the track and to pre-load the wheels in contact with the track when in use.



Figure 2 - The motor control cabinet being wired and tested in the old LAMA room.

The old hydraulic system (Fig 4) is in the process of being removed and the new space freed up for a telescope hydraulics system upgrade. The EPA concerns have been eliminated and heat produced on the 5th floor has decreased due to the decrease in energy consumption. A comparison between the old and new systems indicates an energy savings from the newer system of between \$20k to \$40k a year and a pay-off for the equipment in 3 to 6 years.

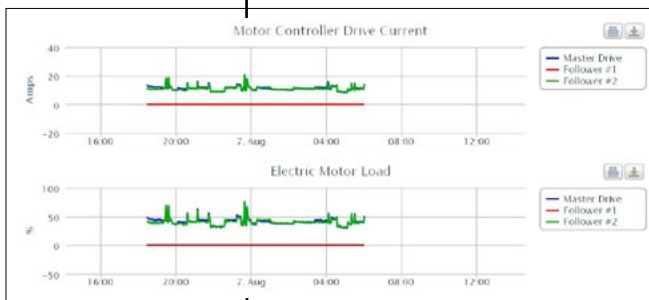

Figure 3 (above)

One of the graphs providing remote monitoring on the electric motor operating condition.

Figure 4 (right)

A mosaic view of the old hydraulic drive power plant on the first floor of the summit building



One Year of Remote Operation: a remote observer's perspective

Peter Forshay

One of the most significant changes at CFHT in 2011 has been the implementation of remote observing. This new observing mode has fundamentally changed the way data is gathered at CFHT, which in turn has had a major impact on summit personnel. No longer do we need two employees in two different roles to be physically present on Mauna Kea. Instead, we are replaced at the summit by network connections, remote power controllers, and pan-tilt-zoom cameras. However, the human direction of Queued Service Observing remains intact and the merging of old summit operator roles has given rise to a new position at CFHT: the Remote Observer. As a newly-minted RO myself, this past year of remote operations has seen some significant changes in the role the observer plays and the demands of the job.

In certain respects though, the role of the observer has changed very little over the last year, easing the move to remote operations greatly. The Observatory Automation Project had been progressing for the past few years, and during that time the systems and software had been gradually evolving to accommodate remote observing. This evolution was guided by the notion that the observing environments at both the summit and Waimea should be as similar as possible. So, when the time came to execute the move to Waimea, we had already been working with something very similar to the remote observations setup for some time. From the observers' standpoint, the transition could not have been more seamless.

However, in many ways the life of an RO has changed drastically with the advent of remote observing. The change of elevation has eliminated the effects of dehydration, altitude sickness, and oxygen-deprived sleeping conditions that are inherent to working on Mauna Kea. These improvements all lead to healthier and more clear-minded observers. Observing safety has also greatly improved in that we no longer need to drive company vehicles at various hours of the night in potentially inclement weather and have much more readily available medical care in case of emergency.

Access to the office during daytime working hours has also proven to be an asset provided by moving operations away from the summit. Being able to not only discuss an issue from the previous night with an engineer, but even to show them in person exactly what symptoms were displayed in the observing environment significantly improves communication and understanding on both sides when issues do come up. This also potentially allows the observer to discuss queue plans and strategies for the coming night with the Queue Coordinator in person.

But, for me remote observing also represents a fundamental change in the lifestyle mandated by the job of Observer. Shifts on Mauna Kea meant being away from home and isolated from society, friends, and most coworkers for the duration of the shift. Working from Waimea instead means I can now address basic demands of life outside of work during a shift. I can get to the bank, the post office, or the grocery store in between nights if I need to. When I am next observing is not something I need to keep in mind while buying perishable food anymore. If I get ready in time I can even have dinner with friends before the night begins. The feeling that life does not get entirely put on hold for a week at a time is a significant benefit to remote observing for me.

The move to remote observing has not only improved the technological capabilities of the observatory, but has even extended into improving the lives of its employees. There is certainly something to be said for working on the summit of Mauna Kea, surrounded by some of the largest telescopes in the world, watching the sunrise over the Pacific every morning. In my mind though, the sight of the CFHT dome glinting in the far distance as I walk home in the morning with the knowledge that I was in full control of that observatory just minutes ago is equally impressive. All my thanks go to the CFHT staff who made it possible.

Figure 1

The 2-screen and 4-screen panels on the left take care of the control of the summit facility and of the instrument, while the next two screens on the desk are used for the control of the telescope. Summit, weather and sky monitoring screens are hanging on the wall.



New instrumentation

At the end of 2010, two instruments, SITELLE and SPIrou, both beyond feasibility study phase, were selected for further developments, while the 'IMAKA project was encouraged to pursue ongoing feasibility studies.

SITELLE SITELLE



SITELLE is an imaging FTS (Fourier Transform Spectrograph) based on the same concept as SpIOMM, an instrument installed on the Mont Mégantic telescope. SITELLE will offer a 12'x12' field, wide spectral coverage [350nm-900nm], good spatial image sampling (0.35"/pixel), and 1 to ~20,000 resolution.

U. Laval issued a public call for bid, which only ABB answered by March 1st. A best-effort contract between U. Laval and ABB was signed at the beginning of September.

The deliverables for the instrument are currently divided amongst the participating institutions as follows;

- Instrument lead: U. Laval
- Overall instrument development: ABB-Bomem, Inc.
- Collimation optics, mounts for these, and shutters: U. Laval,
- Detector and detector controller procurement: U. de Montréal
- Detector cryostats, controller, cooling systems and related software: CFHT
- Reduction pipeline: U. Laval primarily with CFHT providing integration of their software.

CFHT has agreed to develop the detector systems for SITELLE. U Laval will provide the detectors and the funds for any components. CFHT will provide manpower for the development at no cost to U Laval.

U Laval loaned CFHT a set of accelerometers to measure the vibration environment of the telescope in order to evaluate performance risks and compliance to U Laval Science Based Requirement Documents (SBRD). The CFHT cassegrain environment was found to be very quiet.

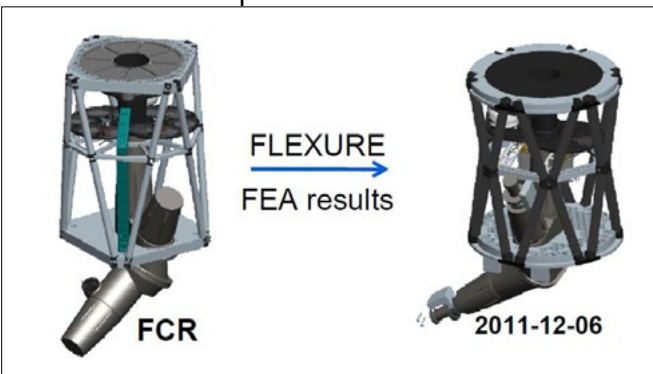

SITELLE's performance model, including modulation efficiency resulting from expected optics quality and OPD errors, is complete. The performance model developed by ABB is an essential part of the Data Simulator, and was used to verify SITELLE's compliance with the SBRD. It has also been used to model data artifacts present in SpIOMM's data in order to avoid them in SITELLE.

The open-source data reduction software advanced well over the year. A data simulator for a 1 Mpix "perfect" imaging FTS has been developed at U. Laval. Data cubes of monochromatic sources have been simulated and compared to real data obtained with SpIOMM. SITELLE's performance model (including jitter, detector noise) was implemented during the summer, as well as a library of sources. A U. Laval student spent a

month at CFHT over the summer to work with CFHT science staff on the SITELLE data simulator.

The optical design has evolved to minimize lens costs and to accommodate detector back focal requirements. Quotations have been obtained for the lenses.

In mid-October, ABB held a kickoff meeting for their development work with CFHT, U. Laval and U. de Montréal participating by teleconference. The kickoff meeting was followed a week later by a final conceptual design review for the instrument. The outcome of the review was very positive; the main technical challenges being the cemented beam-splitter that has stringent wedge and flat-

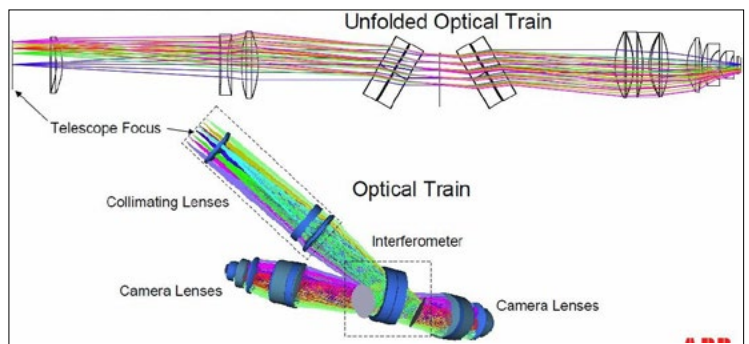

Optical design

The initial optical is shown above. While it evolved during the year, it follows the same concept and will likely be frozen in mid-2012.

Instrument design evolution
On the right is the preliminary design as of December 2011, to be compared with the Final Conceptual Review design on the left. More work is still to be done to reduce mass and moment.

ness requirements and the control of vibrations in the instrument. In both cases, the risks have been thoroughly identified and reasonable risk management measures are being implemented. Since September the ABB systems engineer and technical lead have been communicating frequently with CFHT.

The milestones for the project as laid out by ABB are the following;

- mid-February 2012: Interface freeze point; all parties agree to fix electrical, mechanical and optical interfaces. This is the time CFHT and Laval are proposing that a PDR is held.
- June 2012: Critical Design Review.
- mid-October 2012: All deliverables due to ABB are received. The detector system developed by CFHT must be complete and delivered at this time, ready for integration.
- March 2013: Pre-shipping acceptance tests in Québec.
- April 2013: Delivery of the SITELLE instrument to CFHT. Within 3-months of receipt at CFHT final acceptance testing must have been completed and a 1 year warranty provided by ABB will come into effect.



SPIROU

SPIROU, an near-infrared spectro-polarimeter, was proposed by Jean-François Donati (IRAP, Toulouse). It is a natural extension of the visible spectro-polarimeter ESPaDOnS to the near-IR. ESPaDOnS is currently one of the three main CFHT instruments, used for two very successful Large Programs as well as by many PIs.

SPIROU will be unique not only as IR spectro-polarimeter; it will also offer the possibility of measuring radial velocity accuracy, opening the possibility of Earth-size extrasolar planets around M-dwarf stars.

SPIROU entered in Phase B at the beginning of 2011 with the following science requirements:

- Spectral domain: 0.98-2.4 μ m (w/ full coverage up to at least 2 μ m) spectral resolution > 50,000 (70,000 if possible)
- Radial velocity accuracy < 1m/s
- S/N=150 per 3km/s pixel in 1hr @ J=12 & K=11
- Thermal instrument background < sky background, ie J>15.5, H>13.5, K>13.0
- All polarization states accessible with >99% efficiency and <1% crosstalk over full spectral domain

SPIROU plans to essentially concentrate on two main scientific goals. The first one is to search for and characterize habitable exo-Earths orbiting low-mass and very low mass stars using high-precision radial velocity spectroscopic measurements. The second main goal is to explore the impact of magnetic fields on star and planet formation, by detecting magnetic fields of various types of young stellar objects (e.g. young FUOr-like protostellar accretion discs, classical T Tauri stars) and by characterizing their large-scale topologies.

The first half of the year was spent building an instrument team spread over many institutes in France, (IRAP-Toulouse, IPAG-Grenoble, OHP/LAM-Marseille), Switzerland (OG-Genève), Canada (UdM-Montreal, HIA-Victoria), Taiwan(AISAA-Taipei), and Hawaii! Following a successful Phase B kickoff meeting in late June, the SPIROU team started to work under a new management structure outlined hereafter:

- Co-Principal Investigators: JF Donati / IRAP, R. Doyon / UdM
- Co-Project Scientists: X.Delfosse / IPAG, E.Artigau / UdM
- Project Manager / Deputy Project Manager: D.Kouach / IRAP, D.Loop / HIA
- System Engineer: L.Saddlemyer / HIA
- Lab Project Managers and/or Institutes' correspondents: S.Y. Wang / ASIAA - G.Barrick / CFHT - L.Pares / IRAP - O.Hernandez / UdM - F.Pepe / OG - F.Dolon / OHP- LAM - X.Delfosse / IPAG

At CFHT, the management of the project is organized as following:

- Contracts management: CFHT Executive
- Project Scientist: Karun Thanjavur
- Technical manager: Greg Barrick

The SPIROU spectrograph

This design was presented at the mid-term review held in early December.

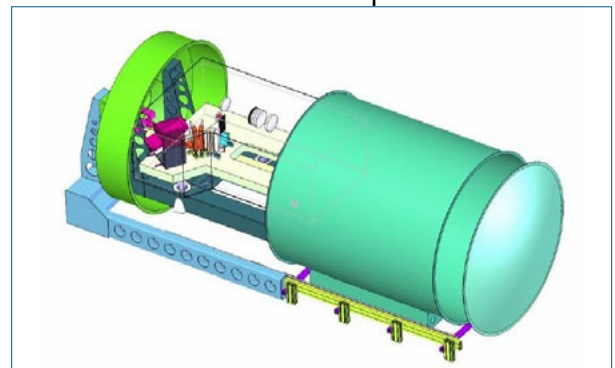

A first mid-term meeting of the SPIRou collaboration in December was an opportunity to gather the main players and review the most critical areas of the project.

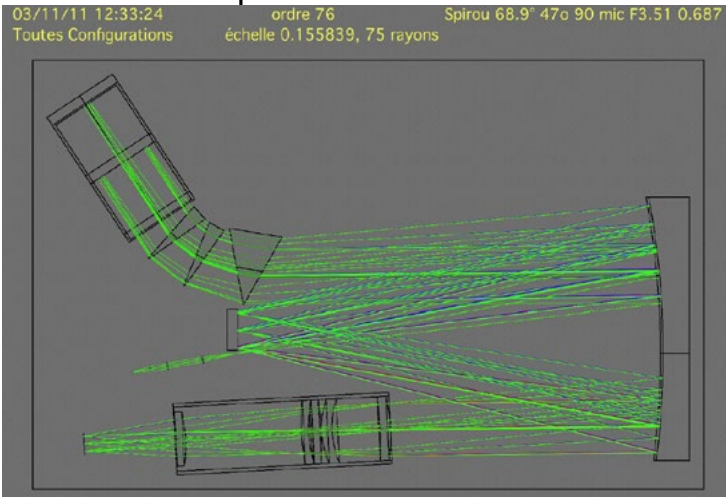

Optical design of the spectrograph

This is the design prepared for an R2.6 grating.

There is no convergence on a single optical design, as there are still uncertainties on the selection of the grating (R2.6 or R4). The R4 solution is simpler but requires the more expensive but higher performance R4 grating mode (pixel size, instrument profile). Unfortunately, at the time of the December meeting, it was not clear if such a grating could actually be manufactured for the project on a schedule and at a cost compatible with the development of the instrument.

At the end of 2011, the team are still in the mode of examining technical solutions and have not yet closed the loop on costs and trades. In 2012, the project will go through another progress meeting in May and is counting on a Preliminary Design Review to be held in October. Much work is still to be done before the PDR, but the team is strong and has the ability to design SPIRou and to solve the remaining technical problems: the procurement of the grating, the performance and cost of the long fibers, and the procurement of the H4RG detector. While SPIRou will uniquely open the K band to both radial velocity measurements and magnetic field studies, the utility of the K band for RV surveys will have to be further studied. By constructing mock surveys, the team will also be able to provide a better estimate of the number of nights required to achieve SPIRou's main scientific goals. The PDR will also present a more accurate schedule and budget for an instrument which is both challenging and exciting!

IMAKA

Following a series of highly successful wide-field imagers, IMAKA is proposing an instrument which will not compete with the new generation of imagers like Hyper-Suprime-Cam, the Dark Energy Camera, or ultimately LSST in term of field size. Instead, it will focus on one of the unique characteristics of the sky over Mauna Kea: its turbulence profile, particularly suited to Ground Layer Adaptive Optics (GLAO) applications. The best image quality on a wide-field of view is the main driver for IMAKA.

The ultimate science requirements of IMAKA indeed reflect this driver: - Field of View as large as possible, with a goal of 1° diameter - Image Resolution 0.3" (median seeing, r-band) - Sensitivity/Limiting Magnitude $\Delta mag \geq 1$ over MegaCam at all wavelengths (median seeing) - Spectral Coverage/Resolution [340nm-1100nm] (at least grizY).

In order to meet these requirements, IMAKA will benefit from the improvements brought by the Dome Venting Project (see next page) and from a novel approach bringing together GLAO and OTCCDs (orthogonal transfer CCDs). The GLAO component will have ~20x20 actuators, using ~6 NGS (natural guide stars) on about 1° diameter field, yielding a sky coverage > 95% ultimately limited by free-seeing. On the OTCCD side, 100-150 Tip/Tilt natural guide stars of magnitude $r \sim 14.5$ (sky coverage ~ 50% at the NGP) will be used. The spectral coverage will be [400-110nm].

The plan initially proposed was to develop a design concept of the full IMAKA instrument. More conceptual studies were commissioned. They demonstrated the complexity of the optics and the resulting complexity of the

mechanical setup needed to accommodate the optical components on the current telescope. In face of the complexity of the optics, the current demonstrated state of GLAO, and the likely funding profile available for IMAKA, it was decided to depart from the initial path: Instead of pushing forward to the final IMAKA as quickly as possible, the team decided to devise a phased-sequence of on-sky demonstrations that progresses from the very simple multiple-wavefront sensor experiment over IMAKA-sized fields, to a 14-arcminute "open-loop" GLAO+OTCCD science demonstrator (SD), to the final full-field Imaka.

An IMAKA concept

A prime-focus configuration with a split field providing two 1/2° x 1° fields.

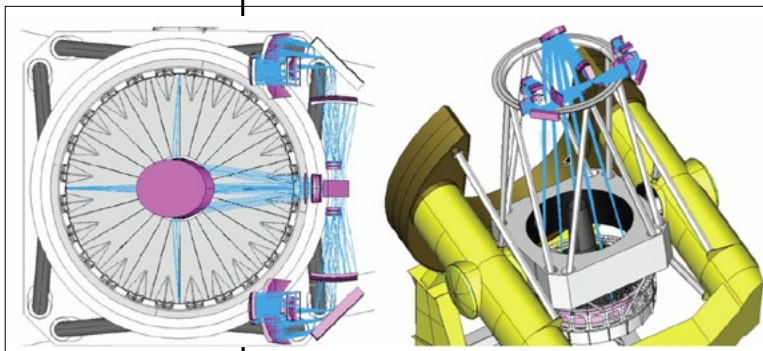

This new approach provides a way to tackle technical risks in pieces, reduces the financial cost and risk to the Corporation, and, with its smaller increments, opens the possibility for other funding sources and other collaborations. The envisioned SD field of view still subtends a solid angle an order of magnitude larger than any other GLAO system and the field over which the WFSs acquire guide stars is the full `Imaka field of view (e.g. 0.9 deg diameter) so it demonstrates the performance of the full `Imaka. Importantly, the instrument demonstrates in each phase the `Imaka science and tackles a specific technical risks. The plan brings flexibility to the program in terms of the amount and timing of funding, the composition of the team, and the overall exposure to risk.

As a 10'x10' near-IR GLAO imager is one of the future instruments envisioned by Gemini, contacts were made to see how some synergy in the demonstrators could be identified to mitigate the costs while fostering collaboration between the observatories. Subaru has also been approached, though their plans related to GLAO are at a very early stage. Expect exciting developments in 2012!

GRACES

Preliminary studies of a Gemini Remote Access to CFHT ESPaDOnS Spectrograph (GRACES) took place over the year in collaboration between CFHT, Gemini, and the Hertzberg Institute of Astrophysics (HIA, Victoria), with HIA designing and fabricating the optical link and all necessary hardware to inject the light from the Gemini-North telescope into the fiber, then slicing the fiber output image and injecting it into the Espadons spectrograph.

Much of CFHT's effort has involved defining the scope of work together with the principals at HIA. On the astronomy side, CFHT has provided performance estimates for the GRACES instrument to allow Gemini to decide whether or not this project is of further interest. A very strong design requirement is that the modifications to ESPaDOnS are such that nothing is touched in the current ESPaDOnS instrument and that all of the modifications for GRACES be additions to the instrument rather than changes to existing parts.

First estimates of the performances of GRACES show that it could offer to Gemini North users a ~50,000 resolution spectrograph with performances in the red similar or better than HiRES on the W.M. Keck telescope. GRACES was funded by Gemini as an experiment at the end of 2011 and should see first light in late 2012 or early 2013. If on-sky performances of ESPaDOnS seen from Gemini are up to the current expectations, GRACES will move from an experimental stage to an operational phase, pending an agreement between the two observatories. It could mark a new step of inter-observatory resource sharing on Mauna Kea.

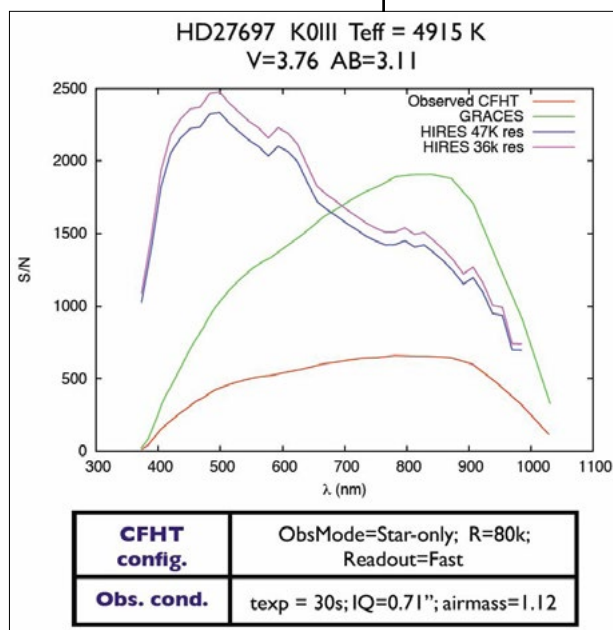

GRACES performances

compared to ESPaDOnS at CFHT and HiRES at Keck (based on exposure time calculators)

Ten Years Ago...

From the 2001 Annual Report

The start of **Queued Service Observations (QSO)** began extremely smoothly for such a complex and difficult undertaking. Under the attentive care of the QSO team, the entire process from the proposal submissions to the data collection functioned smoothly from the very beginning. Over the course of the 104 nights assigned to QSO, more than 8000 exposures were obtained for 67 science programs. Of these, 21 programs received 100% of their requested images, and most of the rest received over 75% of the data, matching the requested conditions. This impressive level of success was achieved despite losing 22 nights to bad weather.

Under the leadership of Christian Veillet, CFHT Senior Resident Astronomer, a committee of scientists in all three communities presented a comprehensive plan with detailed scientific goals for a five-year observational program, the **CFHT Legacy Survey (CFHTLS)**, to be conducted with the new MegaPrime facility. After serious reflection on their needs, the University of Hawaii decided not to participate in this work. Nevertheless, at its December meeting, the CFHT Board approved the allocation of up to 60% of the best dark and grey time available to Canada and France for the Survey. While a number of specific details remain outstanding at the time this is being written, the Legacy Survey has been defined with enough scope to make a significant and lasting contribution to Astronomy

Next Generation CFHT

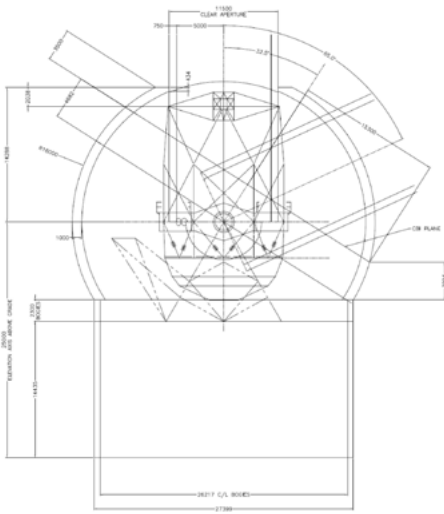

The ngCFHT concept had begun as a grass roots effort in 2010. The November 2010 CFHT Users Meeting in Taipei, Taiwan, was a very timely opportunity to advertise the concept to the CFHT community. 2011 was a year of crystallization of the ngCFHT concept: a 10-m class telescope dedicated to wide-field multi-object spectroscopy: something many want but nobody has!

Other “new” projects were developed concurrently. On Subaru, the Prime Focus Spectrograph, a lighter version of WFMOS once envisioned in the instrument development plan of Gemini, moved on and started to be considered seriously by a wide collaboration of Japanese, US, French, and Brazilian institutes. The BigBOSS project, conceived to install an multi-object spectrograph on the 4-m Mayall telescope modified to give a larger field, was developed under the leadership of the leadership of the DOE Lawrence Berkeley National Laboratory, with partners in other institutes in the US and abroad too.

The ngCFHT efforts were led by colleagues (P. Coté, A. McConnachie, and D. Cramp-ton) at the Herzberg Institute for Astrophysics (HIA) in Victoria, Canada. A Kickoff Meeting for the ngCFHT Concept Study took place at the end of January, with the attendance of colleagues beyond the main partners of CFHT (C,F, andH): colleagues from Brazil, China, Taiwan were also present, as well as from Japan as a synergy could be possible with PFS.

China, Taiwan were also present, as well as from Japan as a synergy could be possible with PFS.

The main parameter specifications of the initial concept are given in the table on the right. Obviously they are likely to change as the project is better defined and the member of the ngCFHT brings their ideas on the table.

The ngCFHT team organized the community to work on the concept, refine the science case and look at potential programs and their magnitude in term of telescope time.

To re-examine the baseline specifications, survey design and observing strategies, ten science working groups (SWGs) were assembled during 2011. The SWGs were chosen to cover the broadest possible range of science topics: exoplanets, the interstellar medium, stellar astrophysics, the MilkyWay, the Local Group, nearby galaxies and clusters, galaxy evolution, QSOs and AGNs, the intergalactic medium, and cosmology.

The basic parameters for two “strawman” surveys are shown in the table on the right below. The bulk (80%) of the observing time is equally divided between bright- and dark-time surveys; in this model, high-spectral resolution observations of compact and/or bright objects (stars, quasars, nearby galaxies) are collected during times of high moon illumination, while dark time is reserved primarily for lower-resolution spectroscopy of the faintest objects (distant galaxies, quasars, etc). According to the baseline design, the remaining observing time (20%) is reserved for PI-led programs and/or “Key Projects”.

As ngCFHT will be working in Queued Service Observing mode, large surveys and PI programs, even small, can coexist without any problem: such a mode will open exciting opportunities to all, giving to the new observatory a broad appeal beyond the usual big players of observational cosmology and galactic astronomy.

Parameter Specification	
Primary Mirror	10m (segmented)
Field of View	1.5 deg ² (hexagonal)
Wavelength Range	370 - 970 nm
Image Quality	FWHM < 0.55" (free atm. 0.40 0.05)
Total Throughput	15% (low and medium resolution) 18% (high resolution)
Number of Fibers:	3200 (for all resolutions)
	800 (for high resolution & complete coverage)
Spectral Resolution (R)	1500 (370-650 nm)
	3500 (630-970 nm)
	5000 (480 - 550 nm / 815-885 nm)
	20000 (480-680 nm)
Fiber Diameter	1.1500 (core)
Positioner Patrol Region	10000 diameter
Configuration Time	40 seconds

Bright Survey (40%)	
Areal Coverage	$\Omega_{tot} = 10,000 \text{ deg}^2$
Spectral Resolution	R = 5000, 20000
Sky Brightness	$\mu(g) < 21.1 \text{ mag arcsec}^2$
Depth	g 19.7 mag (1hr at R=20000; S/N = 20 per Å)
Dark Survey (40%)	
Areal Coverage	$\Omega_{tot} = 10,000 \text{ deg}^2$
Spectral Resolution	R = 1500, 3500
Sky Brightness	$\mu(g) > 21.1 \text{ mag arcsec}^2$
Depth	g $\approx 23.1 \text{ mag}$ (1hr at R=3500; S/N = 5 per Å)

Since the study made by Grundman (1997), it is clear that the telescope pier and overall size are big enough to easily accommodate a telescope 10-m in diameter. However, before going further, it is important to actually verify that the existing structure supporting the telescope (the telescope concrete pier) can accommodate a 10-m telescope as envisioned for ngCFHT, and that the building structure housing the offices and supporting the dome can support the dome required for such a telescope.

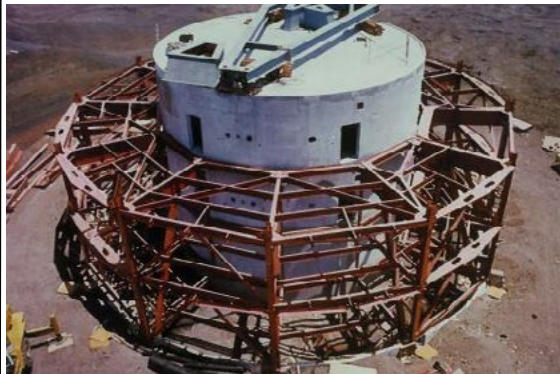

The pier is seen during construction with the base (A-frame) of the telescope already installed at its top. The metallic structure being erected around will ultimately support the dome.

A first study looking at the telescope pier was contracted to Empire Dynamic Structures Ltd. (DSL) in collaboration with HIA and UBC. DSL is uniquely qualified due to their extensive experience in telescope and enclosure design and construction worldwide. Specifically, on the summit of Mauna Kea, DSL's work includes the CFHT enclosure, Keck telescope and enclosures, Gemini enclosure and Subaru enclosure, and most recently the telescope structure and calotte enclosure design for the Thirty Meter Telescope (TMT) project.

Once all the drawings were retrieved and the last minute changes made in the mid-seventies when pouring concrete at the summit were understood, the pier was modeled and its load capacity checked, including in earthquake conditions using the current building code, more stringent than 35 years ago. The pier was found to be good enough overall to handle an ngCFHT telescope as described earlier. The only thing to check is the soil resistance as it could be slightly insufficient to handle a strong earthquake without allowing the pier to slightly tilt. If indeed the soil is not strong enough, there are remedies which would not harm the site more than already done. This is good news!

The HIA/UBC/DSL turned its attention to the building (or Enclosure Pier). This second study is now ongoing and should be completed by early 2012. It will check the ability of the metallic building surrounding the pier to handle a new dome, again with the new building code as a guide for the earthquake simulations.

A first concept of the done was also prepared by DSL. It shows that a new dome can be designed to house a telescope like ngCFHT in an envelope which is very close to the envelope of the current CFHT dome. It is indeed very important that the 3-D print of the new facility stay within the current one, as no development on the summit ridge can expand the impact of the observatory on Mauna Kea. The current concept is based on a calotte-design à la TMT (see figure below).

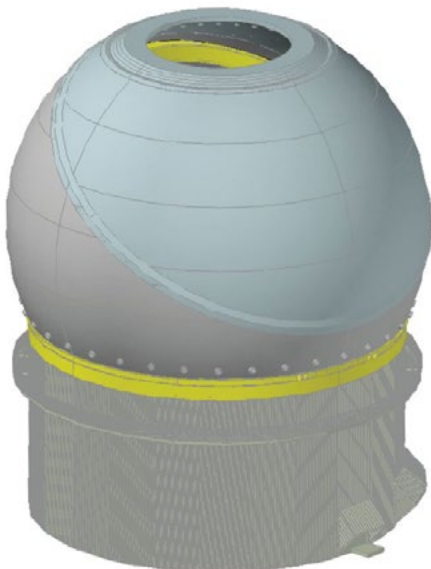

Many presentations were made by the ngCFHT team as well as the CFHT staff to raise interest in the project and expand the collaboration within the CFHT partnerships and beyond, in France, Canada, Japan, Korea, Taiwan, Italy, Thailand (APRIM 2011), Australia, Chile, at the STSci in Baltimore or ESO in Garching... Scientific conferences, national meetings, bilateral collaboration negotiations, they were all excellent opportunities to advertise an exciting project which will need a broad support to become reality. Interestingly enough in these times of budget uncertainties, the sum of PFS and Big-Boss budgets is not far from the cost of an ngCFHT... Unfortunately, wanting to be the first or not being ready to wait are still reasons to move on in an inefficient way, when looked at globally.

Gatherings around ngCFHT will be organized in 2012 using various opportunities offered by international meetings (SPIE, UAI) and the status of ngCFHT will be presented in the various national meetings organized in the CFHT users communities.

You can follow the evolution of the ngCFHT project here.

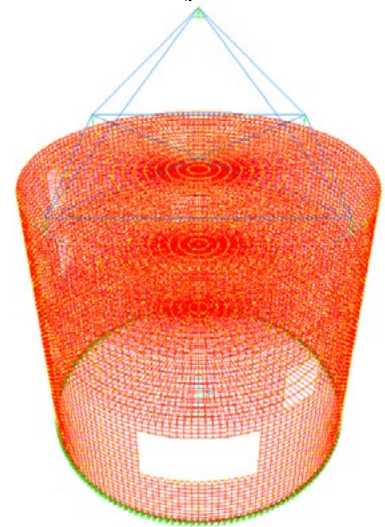

Top: the meshing modeling the pier.

Bottom: modeling the stress from an earthquake load.

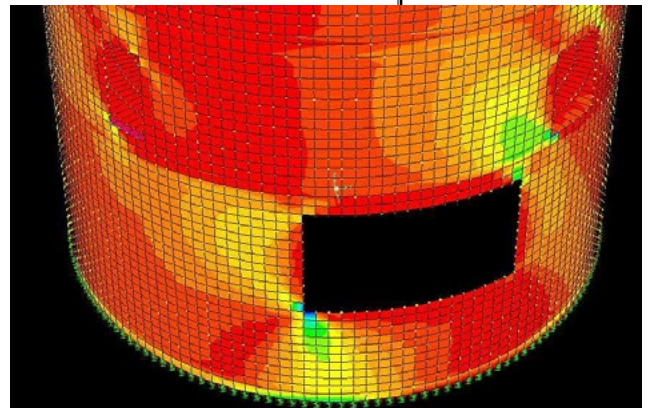

Outreach



Waimea Keiki Fest
Eder Matriori and Lisa Wells with kids at the Keiki Fest on a gorgeous Waimea day

Various visits of the headquarters and the summit were organized for groups and special guests, such as the Japanese Science Minister early in the year. Chinese members of the press visited the observatory in preparation of the 2011 Asia-Pacific Economic Cooperation forum: a good opportunity for CFHT to advertise its collaboration with the Chinese astronomical community, which started with the second semester of 2011. Numerous summit tours were given by staff to the winners of silent auctions organized by local schools and non-profit organizations.

Local schools were visited, bringing astronomy and its actors in the class room. CFHT organized a star gazing party with Kealakehe High Astronomy Class, and participated in the Relay for Life Fundraiser (CFHT teamed with Keck, raising over \$7,500 for the American Cancer Society).

Star Gazing party

On the front lawn of the headquarters on a December evening

The third Solar System Walk, in partnership with the Keck Observatory, was again well-attended and ap-



CFHT's outreach program has been again very active, emphasizing as usual activities directed toward the local community, thanks to the contribution from many staff members. Nadine Manset served in the leadership role of the outreach programs with assistance for logistical details from DeeDee Warren. The Astronomy Group has supported all astronomy-related activities and many members of the staff continue to show their dedication by conducting observatory tours, visits, and community-related activities.

CFHT participated in many fairs and festivals: Kohala/Haulala Middle School Science Fair, Kohala Middle School Science Fair, Astronaut Ellison Onizuka Day at UH Hilo, East Hawaii District Science and Engineering Fair and Astro Day in Hilo, Waimea Healthy Keiki Fest, Waimea Country School Science Fair, and Girls Exploring Math and Science Day.



Astro Day in Hilo - Working with the 3-D model of Orion



Onizuka Day in Hilo - Working with Orion's 3-D model

preciated. CFHT participated in the International Observe the Moon Night, setting up telescopes on its headquarters front lawn. Unfortunately, the weather did not cooperate!

The traditional CFHT Star Gazing Party, scheduled to immediately follow the Waimea Christmas Parade in the evening of the first Saturday of December, gathered again a good crowd.

Astronomers gave talks for the Universe Tonight conference series at the Hale Pohaku Visitor Station and on 'Oahu for the *Alliance Française*.

Comings and Goings



HERB WOODRUFF left CFHT in December 2011 after six years as a UNIX system administrator. Herb made a great contribution to CFHT technically, advancing CFHT's large computer infrastructure and developing an IP telephone system for both Waimea and the Summit. Herb was also a good friend to many people at CFHT and the Big Island community who are wishing him the best in his next adventure. He moved to Toronto to be closer to his girlfriend and to move back to ski-territory.

JEFF WARD retired in October 2011 to pursue a career in farming after having served in various capacities at CFHT for 15 years. He started his career here as a telescope operator and then moved into the Optics Group as an electronics engineer and later into the Detector Group, which was eventually consolidated into the Instrument Group, as detector engineer. He made significant contributions to the major instruments at CFHT – commissioning and integrating MegaPrime, developing the WIRCam camera system and integrating a new high-QE detector for ESPaDOnS. It is no surprise that he has chosen to be a farmer since it fits well with his previous eclectic mix of occupations as a roofer, radio technician and longshoreman. We wish him success in his new pursuit.

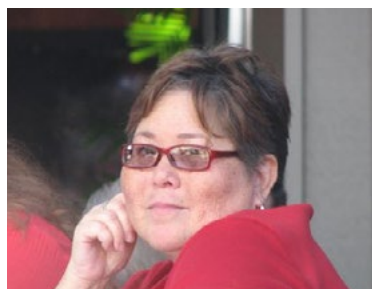

LINDA FISCHER left CFHT in mid-2011 after almost 24 years of service in our business office. Linda will be missed for her vast memory of where and when things were purchased, her perfection in processing payroll, and the effortless way she managed staff benefits. She was a highly appreciated colleague who was a great resource to finding what was needed yesterday, with a sympathetic ear and a sharp sense of humor. Linda was also instrumental in creating incredible Christmas parties for our keikis over the years. She is now enjoying retirement and spending more time with her family and friends.

LIZ BRYSON retired in December 2011 after a little more than 29 years of loyal services. She was hired in the early days of CFHT, in January 1983. Over the years, Liz built and maintained the library services at CFHT. Her academic background and her eager attitude to learn the tools of the trade provided quick and efficient library services to the scientific and technical staff. Liz also became a recognized Librarian in the international community and her CFHT Oral History project was a great success. Above all, Liz was a very joyful colleague who would gladly share her sense of humor with her colleagues. The opening session of the Dewey Decimal Colloquium will remain part of the history of CFHT.



RUSTY LUTHE left CFHT at the end of June 2011 after being with us for almost 11 years. John was hired as an Observing Assistant in July 2000. His duties with CFHT were to operate the telescope as necessary to perform the observations required by the Astronomers. He had a good sense for predicting the weather, an important skill when working at the summit of Mauna Kea. He paid very good attention to safety and made sure that everyone under his responsibility got off the mountain safely. John also participated in the transition to QSO observing in the early 2000 and again was involved in the transition to Remote Observing in the 2009-2010 era. We wish him the best of luck in all his future endeavors.



SARAH GAJADHAR officially resigned from CFHT in November of 2011 after 6 years as an Instrument Engineer. She was instrumental in ushering CFHT into the new era of remote observing, having served as the Observatory Automation Project manager. Her guidance and leadership on the project culminated into a successful transition in February 2011 and its subsequent nearly flawless operation. She will be spending her days now as full-time mother caring for her three year-old and newborn sons and doing some consulting work during her free time.

TEDDY GEORGE left CFHT in June 2011 after being employed by the company for a little more than 8 years. He was hired as an Observing Assistant in May 2003. At the time of his hiring, CFHT was mostly operating in classical mode but had already started to observe a fair part of the programs in the QSO mode. Toward the end of the decade, Teddy was involved in the transition to Remote Observing. Teddy's ever-constant positive demeanor was a plus, particularly when working at the 14000 ft elevation. We wish him the best of luck in all his future endeavors.



2011 Financial Resources

The three Member Agencies supported the CFHT annual budget in 2011 as shown in the table at the right, in US funds. These contributions reflect a 5% decrease in 2011 over the prior year.

Agency Contributions	
NRC	3,098,494
CNRS	3,098,494
UH	718,490
Total	6,915,478

Under a collaborative agreement with CFHT, the Academia Sinica Institute of Astronomy and Astrophysics of Taiwan and the Brazilian Ministry of Science and Technology remitted \$281,250 and \$373,500, respectively, as reimbursement for costs associated with its use of the Corporation's facilities. Other sources of funds included \$16,906 from mid-level facility use credits, \$29,233 from distribution of educational materials, \$10,506 in staffing cost reimbursements related to work done for other Mauna Kea facilities, and \$30,539 in earned interest.

Operating Fund Expenditures	
Observatory facilities and operations	587,075
Base facilities and operations	678,911
Instrumentation	74,946
Science	59,912
Outreach	32,728
General administrative expenses	388,713
Staffing	4,971,193
Transfer from Reserve	122,000
Total Operating Fund Expenditures	6,915,478

From the operating fund, 2011 expenditures were allocated to the areas listed in the table at left. Overall, resources from all CFHT funds were allocated to the categories of expenditures shown in the pie chart below.

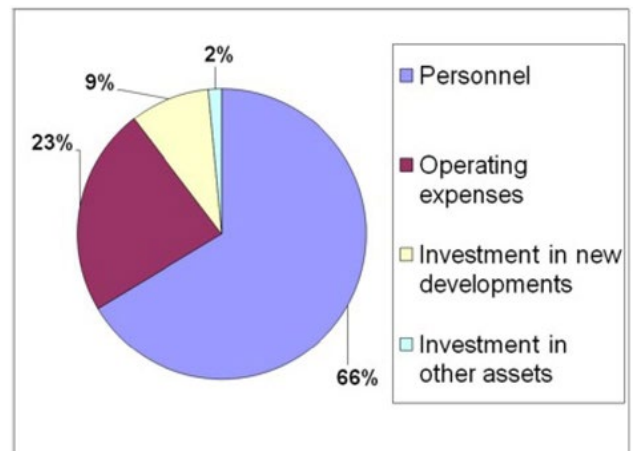

Telescopes from Afar

More than 140 participants gathered at the Waikoloa Beach Marriott Resort on the sunny Kona coast of the Big Island of Hawai'i. The program of the oral presentations below outlines the main topics of the conference:

History

Genet - History of robotic and remotely operated telescopes
Seaman - 3 things your robot should know

Education

Mclin - Using robotic telescopes to teach STEM skills: Undergraduate and high school students

Remote Operations

Veillet - Why to stay away from your telescope at night?
Moody - The Remote Observatory for Variable Object Research (ROVOR)
Springer - The Willard L. Eccles Observatory: Commissioning and development of remote operation capabilities
Aspin - The Uh88, full remote operations of a Mauna Kea telescope
Gajadhar - Retrofitting the Canada-France-Hawaii Telescope for remote operations
Kerr - Switching the United Kingdom Infrared Telescope to remote operations
Bakos - Global networks of small telescopes: HATNet and HATSouth
Oram - Remote operations of laser guide star systems: Gemini Observatory
Riddle - Robo-AO: The first autonomous laser guide star adaptive optics system for 1 to 3 meter telescopes

Remote Observations

Manset - Remote queued service observing at Canada-France-Hawaii Telescope
Kibrick - Operating a wide-area high-availability collaborative remote observing system for classically-scheduled observations
Wirth - More bang for the buck: Lessons learned from remote observing at the W. M. Keck Observatory
Zhu - Remote observing with the FAST telescope

Robotic Telescopes

Smith - The Liverpool Telescope
Guinan - The 1.3m Robotically Controlled Telescope at Kitt Peak - A 50 year old dream realized: Telescope characteristics, current research, and education program
Bohlender - Remote and robotic operation of the Dominion Astrophysical Observatory 1.2-m Telescope and McKellar Spectrograph
Buie - Autonomous operations and use of the Lowell Observatory 0.8-m Telescope
Eastman - DEMONEX: The DEDicated MONitor of EXo-transits
Lehner - The TAOS Robotic Occultation Survey
Hodapp - IRIS - An Infrared Imaging System Dedicated to Monitoring Star-Forming Regions for Variability
Tonry - ATLAS: An asteroid warning system
Agol - Finding habitable earths around white dwarfs with a robotic telescope transit survey
Guyon - Precision photometry with a low-cost robotic wide field imaging system
Milone - Infrared photometry for automated telescopes: Passband selection

Sensing the Environment

Businger - The Mauna Kea Weather Center: Custom atmospheric forecasting support for Mauna Kea
Cuillandre - SkyProbe, monitoring the absolute atmospheric transmission in the optical
Riddle - The Thirty Meter Telescope robotic site testing system

Telescope Networks

Rosing - We keep you in the dark
Martinez - LCOGT sites and facilities
Williams - Sierra Stars Observatory Network: An accessible global network
Henden - A scientific network of small robotic telescopes

Software

Kubanek - Building and operating a network of autonomous observatories with an open source software
Little - Telescope control through CelestialGrid
Rosing - The LCOGT software system
Thanjavur - Artificial intelligence in autonomous telescopes
Walawender - Computer infrastructure for the variable young stellar objects survey

Data Management and Rapid Response

Comeron - Rapid response to transient events at the VLT
Roth - Target of opportunity and time critical queue observations at Gemini Observatory
Jenness - Data management at the UKIRT and JCMT

Four **discussions** allowed the participants to debate on the following topics:

- The challenges of moving existing facilities to remote operation
- The challenges of moving from remote to robotic operation
- Is weather a challenge for remote and autonomous operations?
- Designing new facilities with remote or autonomous observations in mind.

All abstracts, nearly all the presentations, and a good fraction of the corresponding papers are available online on the conference website:
tfa.cfht.hawaii.edu

CFHT organized the conference with the participation of sponsors from the Island and afar (see poster on the right).



Telescopes from Afar
An international conference on remotely operated, automated, and robotic ground based telescopes

February 28 – March 3, 2011
Waikoloa Beach Marriott, Hawai'i

An opportunity to share information on the advancements and developments in the areas of remote observing, remote operation, and automated local and global networking of all sizes of observatories.

Key Topics
History and overview
Economics and motivation
Instrumentation
Target selection, scheduling and queue observing
Event alerting and telescope networks
Monitoring and control of observatory systems
Examples of robotic observatories and retrofitting existing observatories for remote operations
Data handling, reduction, and verification
Weather and environmental sensing

Invited Speakers
S. Businger - Mauna Kea Weather Center
F. Comeron - European Southern Observatory
S. Gajadhar - Canada-France-Hawaii Telescope
T. Jenness - James Clerk Maxwell Telescope
R. Kibrick - Lick Observatory
P. Kubanek - Instituto de Astrofísica de Andalucía
R. Genett - California Polytechnic State University
W. Rosing - Las Cumbres Observatory Global Telescope
R. Seaman - NAOJ
R. Smith - Liverpool John Moores University
M. Lehner - Academia Sinica Institute of Astronomy and Astrophysics

Program Organizing Committee
A. Adamson - Gemini Observatory
S. Gajadhar - Chair - Canada-France-Hawaii Telescope
R. Genett - Co-chair, California Polytechnic SU
J. Martinez - Las Cumbres Observatory Global Telescope
J. Melnick - European Southern Observatory
C. Veillet - Canada-France-Hawaii Telescope
J. Walawender - Co-chair - University of Hawaii

Important dates
Financial aid: until December 15, 2010
Early registration (\$250): until January 15, 2011
Late registration (\$350): after January 15, 2011
Oral presentation deadline: January 15, 2011
Poster presentation deadline: February 15, 2011

DFM ENGINEERING INC. GEMINI OBSERVATORY TFA CFHT HAWAII.EDU NOAO TMT

