

2021 CFHT Annual Report

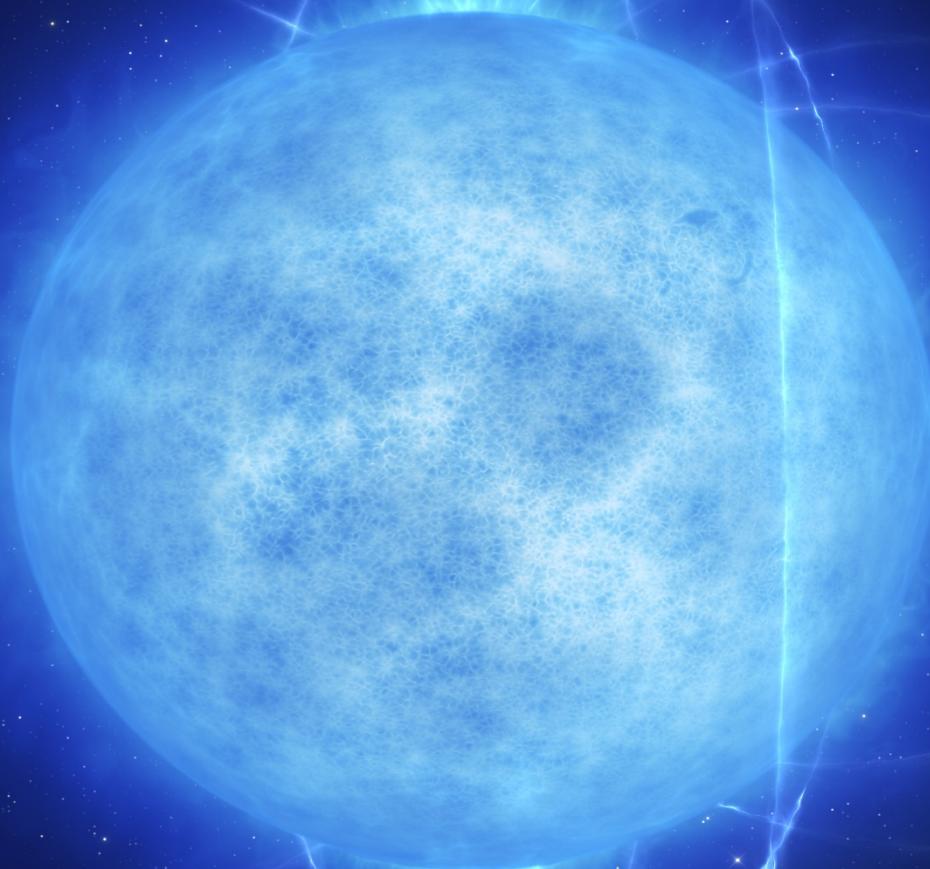

Table of Contents

Director's Message

Assessment of Impact from Decadal Review.....	1
MSE Pathfinder Project.....	2
Associate Partnership Update.....	4
Master Lease Negotiations Update.....	4
COVID Operations.....	5

Science Report

A strange abundance of water in Tau Boötis b.....	6
Magnetism in White Dwarfs.....	6

Engineering Report

Facilities

f/8 secondary coating.....	9
DEC Wrap.....	10
Telescope Hydraulics System.....	10
Dome Vents.....	10
Bridge Crane Access Platform.....	11
Other Facility Upgrades.....	11

Instrumentation

MegaCam.....	14
SPIRou Upgrade.....	15
SPIRouDOnS IRAP/OMP Proposed Design: "VISION".....	16
ESPaDOnS/GRACES.....	17
WIRCam.....	17
Sitelle.....	17

Software

Kealahou Development.....	18
Summit Network Infrastructure.....	21
CAD Security Breach.....	22
Adaptive Scheduling for Transit and Target Monitoring.....	22

MSE Progress

National Strategic Planning Processes.....	23
Expanding the MSE Partnership.....	23
Funding Roadmap.....	24
Contributions Summary.....	25
Project Office Budget Gap.....	26

Administration Report

Finance Summary.....	27
Safety.....	28
Staff Departures and Arrivals.....	29
Organization Chart.....	31
Staff List.....	32

Strategic Communications and Outreach Report..... 33

2021 Publications..... 37

*Front Cover: On the front cover is an artistic rendering of the magnetic field of a white dwarf. An international team of astronomers from Armagh Observatory in Northern Ireland and the University of Western Ontario used ESPaDOnS at CFHT, the ISIS spectrograph/spectropolarimeter and the William Herschel Telescope (WHT), and FORS2 at the European Southern Observatory (ESO) to carry out a spectropolarimetric white dwarf survey out to 20 parsecs from the Sun.

Director's Message

Assessment of Impact from Decadal Review

The Astro2020 report of the decadal review, in my opinion, is very positive for CFHT's Maunakea Spectroscopic Explorer (MSE) project. Specifically, it calls out a funding road map for US involvement with a large spectroscopic survey facility at the \$100 million plus level at the end of the decade (see end of section 2 highlighted below). Astro2020 presents prioritization for funding of facility upgrades that target specific science cases such as time domain astrophysics and highly multiplex spectroscopy. It also prioritizes facility upgrades that allow for US access to wide field spectroscopic capabilities.

“Recommendation: The National Science Foundation (NSF) Division of Astronomical Sciences (AST) should create three tracks within the AST Mid-Scale Innovations Program and within (its share of) the NSF-wide Mid-Scale Research Infrastructure Program. The first track should be for regularly competed, open calls, the second track should solicit proposals in strategically identified priority areas, and the third should invite ideas for upgrading and developing new instrumentation on existing facilities. All tracks should solicit proposals broadly enough to ensure healthy competition. “

The Astro2020 priorities outlined above pave the way for CFHT to apply for a \$20 million level proposal to the NSF for a facility class instrument, the MSE Pathfinder. We anticipate the facility class instrument will retire some of the technical and scientific risks associated with MSE while providing access to the US community for widefield spectroscopic capability. In doing so, it would address two of the three strategically identified priority areas, specifically time domain astrophysics and highly multiplex spectroscopy. It fits well within Section 3 (highlighted below) that calls for upgrading facilities and the development of state-of-the-art instrumentation on existing facilities emphasizing community access in exchange for the instrument development.

“2. The strategic priorities track is an essential addition to the existing mid-scale program structure to ensure that it is responsive to decadal and community strategic priorities. The survey expects that these strategic programs will be at the larger end of the mid-scale cost range (i.e., at the ~\$100 million level). Therefore, partnerships with other organizations or agencies, including internationally, may be desirable or appropriate. Program directors would be empowered to weigh programmatic considerations in balance with the recommendations of external reviews. The survey has identified one top priority for this element, a time-domain astrophysics program and two co-equal areas – highly multiplexed spectroscopy and radio instrumentation.....

Subaru Prime Focus Spectrograph (PFS), or similar surveys, would help to advance science this decade with relatively modest funding, and later in the decade a major (MSRI-2 scale) investment could be made in a larger, dedicated facility.”

MSE Pathfinder Project

MSE/CFHT plans to develop an end-to-end Pathfinder for the Maunakea Spectroscopic Explorer. It is envisioned that the proposal to NSF will be led by MSE/CFHT, with coinvestigators from NOIRLab as well as our collaborators from US universities. The goal of the Pathfinder will be to retire many of the high-level technical risks for MSE by demonstrating on-sky the ability of the major components of MSE and the major software packages in parallel with producing an initial science product that can be shared with the community as well as community access to this wide field spectroscopic capability.

“3. The sustaining instrumentation element is intended to address the pressing need to maintain and upgrade capabilities on U.S.-led telescopes and to develop state of the art instrumentation on existing facilities to keep them at the scientific forefront. With the survey’s top large recommendation being investment in the U.S. Extremely Large Telescope (ELT) program (Sec 7.6.1.1), the need for complementary instruments on a range of smaller OIR telescopes will become more pressing in the coming decade. Upgrades to 6-10 m class instrumentation will ensure the ability to conduct supporting and preparatory science. Smaller telescopes will be essential for conducting surveys and will also serve as testbeds for demonstrating new technologies (Box 6.1). Sustaining instrumentation calls would be open to all facilities, public and private, and would support investments for private telescopes that emphasize community access in exchange for instrument investments (see Sec. 5.1.2 for an extensive discussion of this issue). In addition, these calls would support upgrades to public facilities such as the Green Bank Telescope, Gemini, and CTIO.”

Among the primary science goals of the Pathfinder are time-domain astrophysics: specifically spectroscopic follow-up of transients identified by facilities such as Rubin Observatory and Zwicky Transient Factory to optimize their identification and classification; galactic archeology; and the spectroscopy of stars for stellar abundance studies and stellar evolution studies.

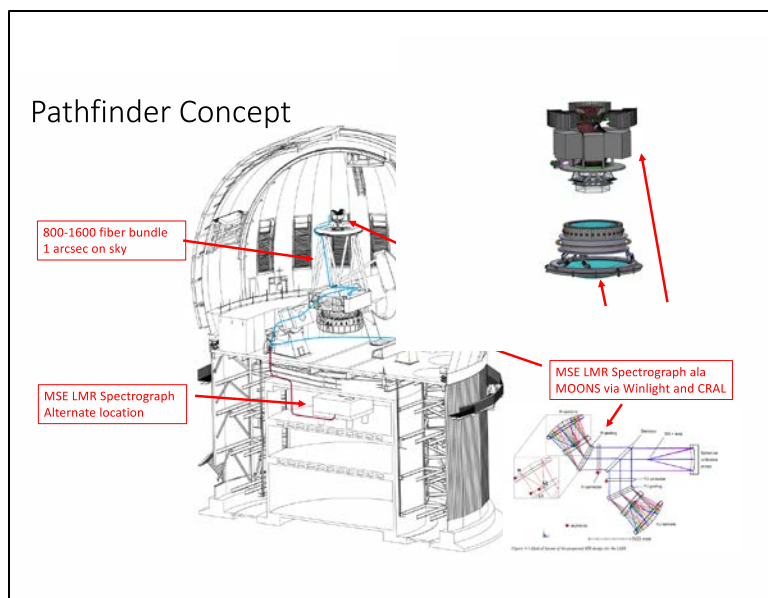

The end-to-end Pathfinder will be one or more multi object spectrographs fed at prime focus from the Canada-France-Hawaii telescope. It will utilize the MSE spectrograph design and a scaled down fiber positioner (from 4000 fibers to approximately 800 fibers) using the same technology as the fiber positioner for MSE. The Pathfinder project will develop the prototype software architecture for MSE including scheduling, targeting, data reduction and analysis, and data management, archiving and database manipulation.

Spectrograph performance at CFHT:

It is envisioned that spectrograph developed for the Pathfinder will be identical to that design for MSE. Spectrographs will be fed by the same fiber size on the sky, one arc second, but because of the smaller aperture of CFHT will be physically 1/3 the size of those for MSE. The net result is that spectrographs will be pixel limited in their resolution. Current spectrograph designs show the possibility of two times the resolution on CFHT as compared to MSE. MSE design resolution is approximately 5000 which brings the CFHT resolution up to 10,000. The possibility of using smaller pixelated detectors for CFHT will be studied. These could conceivably produce a full factor of 3 increase in resolution, up to $R=15,000$.

Rough estimate of sensitivity shows the spectrographs, fiber feed, and widefield corrector all to have similar throughputs between CFHT and MSE so the primary difference is in the collecting area. CFHT is about factor of 10 smaller in collecting area resulting in a reduction of limiting magnitude by about 2 and 1/2 magnitudes. Therefore, at moderate resolution, the Pathfinder is estimated to reach magnitude 22nd magnitude targets at all wavelengths longer than 400 nm (monochromatic AB magnitudes) at a SNR per resolution element of two per hour.

Risk to be retired with the Pathfinder include:

- Targeting and scheduling software to allow the system to interleave multiple large programs, along with PI programs, along with targets of opportunity into each pointing of the telescope in a way that produces the most science for open shutter time while satisfying the need to reach the completeness for the large programs.
- Understanding and developing proper sky subtraction techniques to compensate for errors possibly introduced at an extremely low level by the tilting spine technology, by aberrations within the spectrograph, by improper mode mixing within the fibers, and by temporal and spatial variations in the sky spectra that are sparsely sampled across the field.
- Understanding and developing the data management and data analysis tools in a way that introduces the data archive to a large searchable database managed probably by NOIRLab.

US Science Community Benefit:

As part of the proposal, we would define a community benefit program which would be centered on NOIRLab becoming an Associate Partner of CFHT through our existing Associate Partner program. This would allow for a portion of the time on the pathfinder instrument and possibly other instruments at CFHT to be available to the entire US community through the NOIRLab partnership. NOIRLab would handle all of the logistics associated with US observers i.e., they would provide their own Time Allocation Committee (TAC) and proposal review process as well as time allocation.

Along with this proposal the subject of observing time allocated to the US community was broached with the board of directors at the December meeting who provided a verbal approval of the proposal concept pending review of the proposal. This concept includes 100 to 200 nights of CFHT time on the pathfinder instrument to be allocated to the US community over the course of the grant (three to five years).

Data developed by this spectroscopic capability could be made public to the entire US and CFHT community after the normal embargo period of 6 months.

Associate Partnerships Update

- GRACES agreement has been submitted and signed by both parties.
- National Astronomical Observatory of China (NAOC) agreement has been submitted and signed by both parties. Defined Shared Risk in the new NAOC agreement:
- Academia Sinica Institute of Astronomy and Astrophysics (ASIAA) agreement has been previewed by the Taiwan representative, and discussions are ongoing.
- Currently in discussion with Scott Dahm, United States Naval Observatory, regarding access to CFHT for the completion of their Northern Cap survey
 - Need 170 nights ~ \$4M USD

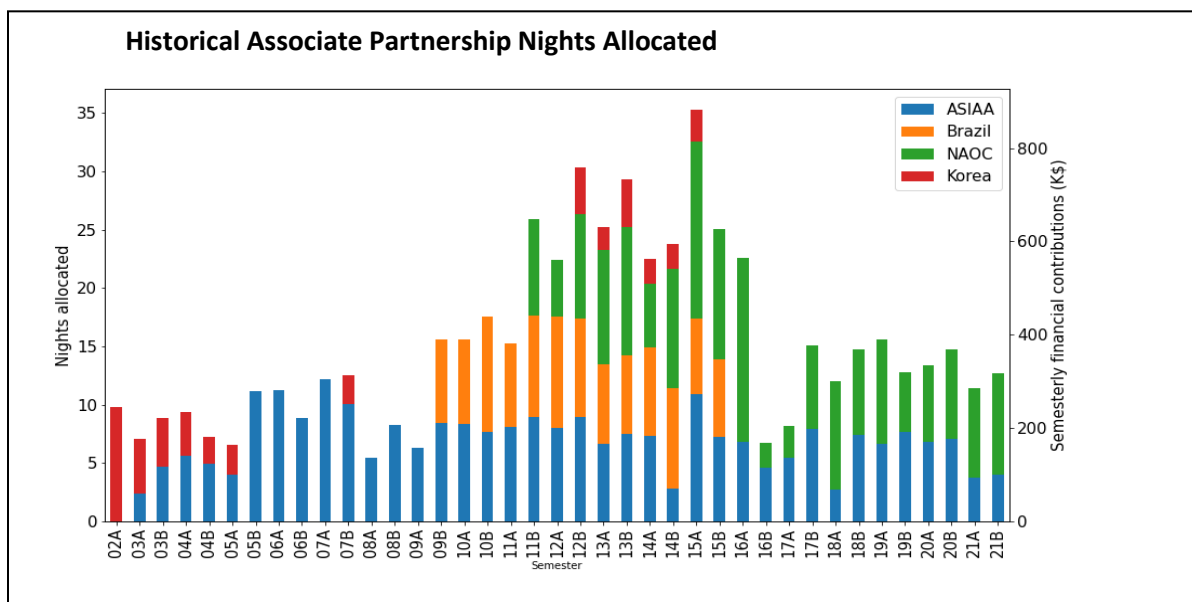

Master Lease Update

On January 26, 2022, HB2024 was introduced in the Hawaii Legislature via the House of Representatives. The bill is an effort to change the responsibility for the management of the summit of Maunakea from the University of Hawaii to a new state entity, the Mauna Kea Stewardship and Oversight Authority (MKSOA). HB2024 is the culmination of a year-long effort by the Mauna Kea Working Group (MKWG), an ad hoc committee of Hawaiian citizens representing various stakeholders on the mountain, to develop a set of guidelines under which the mountain would be managed. The committee was formed at the urging of Rep. Scott Saiki, the Speaker of the House of Representatives for the State of Hawaii.

The wording of the initial draft of the bill was taken almost verbatim from the final report written by the MKWG. After the House and Senate were unable to reconcile their versions of the bill, a Conference Committee was formed to deliberate. The result of those deliberations is CD1. As of the writing of this report, HB2024/CD1 has passed in both the House and the Senate and is awaiting action by the Governor. If passed into law, the Authority will be created on July 1, 2023.

COVID Operations

Company-wide status:

- CFHT does not have a vaccine mandate and does not anticipate implementing one.
- Based on voluntary employee reporting, the company vaccination rate is 95%+.
- Announcements of possible exposure and contact tracing is made only to affected workers.
- Masks required in all common areas; no group meetings greater than 10 people.

Waimea Operations:

- Remote work option is in place with manager coordination. On average, the office is 25% occupied.
- Company policy with regard to exposure and contact tracing follows current Hawaii Dept. of Health and CDC guidelines.

Summit Operations:

- Normal operations and work schedule.
- All summit-based staff are vaccinated.
- No staff or visitors allowed through Hale Pohaku or at the summit without a vaccination or negative COVID test.
- Any known or potential close contact or secondary contact is held back from the summit until cleared by negative testing.

Science Report

A Strange Abundance of Water in Tau Boötis b

An international team of astronomers has measured the most precise composition of the hot Jupiter Tau Boötis b's atmosphere, providing us with a better understanding of giant planets. Using SPIRou, a team led by Stefan Pelletier, a PhD student at Université de Montréal's Institute for Research on Exoplanets (iREx), studied the atmosphere of the gas giant exoplanet Tau Boötis b, a scorching hot world that takes a mere three days to orbit its host star.



Artistic rendition of the exoplanet Tau Boötis b and its host star, Tau Boötis. Image credits: Credit: ESO/L. Calçada.

Their detailed analysis, presented in a paper published in the *Astronomical Journal*, shows that the atmosphere of the gaseous planet contains carbon monoxide, as expected, but surprisingly did not identify water, a molecule that was anticipated to be prevalent and should be easily detectable with SPIRou.

Tau Boötis b is a planet that is 6.24 times more massive than Jupiter and 8 times closer to its parent star than Mercury to the Sun. Its host star, Tau Boötis, located 51 light years from Earth is 40% more massive than the sun and is one of the brightest known planet-bearing stars in the sky.

Discovered in 1996, Tau Boötis b was one of the first exoplanets ever detected via the radial velocity method. It was one of the first planets studied with SPIRou which started science operations at CFHT in 2019. The team spent 20 hours observing the exoplanet between April 2019 and June 2020. This exquisite data set allowed the researchers to make a detailed analysis of the molecular content of the hot Jupiter's atmosphere.

Several abundance indicators were measured and most of them were close to or higher than what one would expect looking at the giant planets of the solar system. The problem is with the measured abundance of water vapor. The amount of water vapor measured for Tau Boötis b is much lower than what is expected if the planet is similar in chemical composition to the giant planets of the solar system.

This may be a hint that hot Jupiter's could form much further from their host star, at distances that are similar to the giant planets in our Solar System, and simply experienced a different evolution, which included a migration towards the star. [Journal article](#)

Magnetism in White Dwarfs

An international team of astronomers from Armagh Observatory in Northern Ireland and the University of Western Ontario in Canada published a paper in the *Monthly Notices of the Royal Astronomical Society* sharing new insights into the origin and evolution of the magnetic field of white dwarfs. The team used

ESPaDOnS at CFHT, the ISIS spectrograph/spectropolarimeter at the William Herschel Telescope (WHT), and FORS2 at the European Southern Observatory (ESO) to carry out a spectropolarimetric white dwarf survey out to 20 parsecs from the Sun.

More than 90% of the stars of our Galaxy end their lives as white dwarfs. Although many have a magnetic field, it's still unknown when it appears on the surface, whether it evolves during the cooling phase of the white dwarf and, above all, what the mechanisms are that generate it.

At least one out of four white dwarfs will end its life as a magnetic star, thus magnetic fields are an essential component of understanding their complexities. New insights into the magnetism of these stars from the team's survey provide the best evidence obtained so far of how magnetism in white dwarfs correlates with age. This could help to explain the origin and evolution of magnetic fields in white dwarfs.

"White dwarfs are the remnants of stars that have run out of fuel and collapse. By nature, they become cooler and fainter with time," says Dr. Stefano Bagnulo, Armagh Observatory and co-author of the paper. "Observations tend to favor the study of the brightest, most massive, hottest white dwarfs, which are the youngest. In our survey, we chose to include older, fainter white dwarfs with the hopes we could learn more about the continued evolution of these remnants."

The team observed all the white dwarfs from the Gaia catalogue that lack previous high-precision magnetic measurements in the region within 20 parsecs, 65 light years of the Sun, obtaining new data for 87 of the 152 stars in the region. The team took spectra of the white dwarfs using three spectropolarimeters, critical instruments to understanding magnetic fields. Spectroscopy breaks the light from one star into its component rainbow or spectra allowing astronomers to learn more about the object's composition, temperature, etc. An instrument with spectropolarimetric capabilities, like those used by the team, enhances the study of an object by increasing the sensitivity and detection of magnetic fields by more than two orders of magnitude better than spectroscopy alone.

"Most white dwarf observations are made using spectroscopic techniques sensitive to only the strongest magnetic fields, thus failing to identify a large fraction of magnetic white dwarfs," said Dr. John Landstreet of the University of Western Ontario and a co-author on the paper. "Two thirds of the stars in our survey were observed for the first time in spectropolarimetric mode, enabling our team to record previously undetected magnetic fields."

The team used CFHT's ESPaDOnS to make a quarter of the observations for the survey. ESPaDOnS is a high-resolution spectrograph which can be used in a high resolution spectropolarimetric mode for observations like those made by the team. Landstreet was the primary investigator in Canada for the NSERC grant that funded the development of ESPaDOnS' camera and has worked with the instrument since its commissioning in 2004.

The team found magnetic fields are rare at the beginning of the life of a white dwarf. The star no longer produces energy in its interior and starts its cooling phase. These observations demonstrate that magnetic fields do not appear to be a characteristic of a white dwarf since its "birth". Most often, the magnetic field is either created or brought to the stellar surface during the white dwarf's cooling phase.

The team also found the magnetic fields of white dwarfs do not show obvious evidence of decaying over time. The results indicate the magnetic fields are generated during the cooling phase or at least continue to emerge at the stellar surface as the white dwarf ages. This picture is different from what is observed in

larger, hotter magnetic main sequence stars, like Ap and Bp type stars. In these large stars, astronomers find magnetic fields are present as soon as the star reaches the zero-age main sequence, when they start to fuse hydrogen in their core, and that the magnetic field strength quickly decreases with time (details also uncovered with data from ESPaDOnS). Magnetism in white dwarfs therefore seems to be a totally different phenomenon than magnetism of larger, hotter, Ap and Bp type stars.

Magnetic fields in white dwarfs appear more frequently after the star's carbon-oxygen core begins to crystallize. One explanation for the cause of these magnetic fields is a dynamo mechanism, which explains the weakest fields detected by the team. A dynamo mechanism occurs when a rotating object, like a white dwarf or the Earth, contains a molten, electrically conducting fluid. In a white dwarf, the crystallizing carbon-oxygen core may generate the magnetic field in the same way the Earth's molten iron core generates its magnetic field.

While the dynamo mechanism holds potential to understand white dwarf magnetic fields, further theoretical and observational investigation is necessary. Dynamos require fast rotation in an object, a trait not generally observed in white dwarfs. Dynamo mechanisms can explain magnetic fields up to 100,000 Gauss (the Earth's field is 1 Gauss for reference), and astronomers have observed magnetic fields up to several hundred million Gauss in some white dwarfs. The team plans further work to untangle the mystery of white dwarf magnetic fields.

"John Landstreet's used CFHT for decades and brings an expertise to observations that make the best use of CFHT," said Dr. Nadine Manset, ESPaDOnS instrument scientist at CFHT. "After years of observations pushing the limits of ESPaDOnS, these results expand our understanding of white dwarfs and create new questions to be explored." [Journal article](#)

Engineering Report

Facilities

f/8 Secondary Coating:

The f/8 secondary mirror is normally recoated once every five years. The recent coating was delayed for seven years partially due to COVID and because of CFHT's need to source a replacement mercury containment bag.

The mirror was coated in September, and the results were outstanding. The coating piggybacked on the



Mirror just after coating.

modifications made to the aluminizing chamber in August 2020 to improve the coating thickness. An average thickness of 1305 Å across the mirror surface was achieved, a 55% improvement from the 2014 thickness of 840 Å. This result, coupled with that of the primary mirror, validates the improvements made to the aluminizing chamber and gives us confidence in obtaining good coating thicknesses in the future.

Unexpectedly, SPIRou reported a significant improvement in throughput in the Y band (970 – 1070 nm) of about 5% at the maximum with the fresh coating. Since scattering impacts the IR wavelengths much less than in the visible, not much improvement was expected to be seen with SPIRou. Improvements at redder wavelengths than the Y band, as expected, were not seen.

Sitelle also saw improvements in the throughput – an 8.2% increase in the SN3 filter (651 – 685 nm) and 21.7% increase in the SN1 filter (365 – 385 nm).

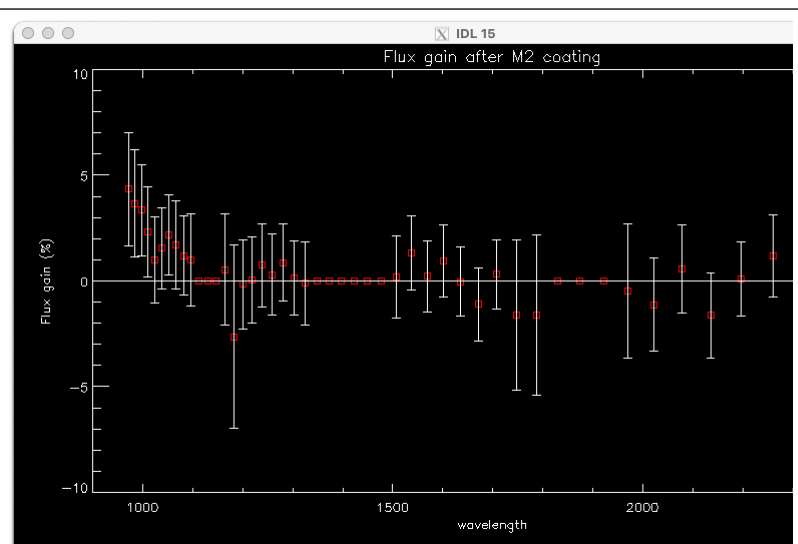

Throughput gain from f/8 recoating on SPIRou based on the first run after coating. Measurements provided by Luc Arnold.

DEC Wrap:

The DEC wrap support system installation was completed at the end of February. Since its installation, there have not been any technical issues related to the declination wrap, and the axis drive currents have been lower and more balanced than previously.

Telescope Hydraulics System:

Testing of the oil and glycol plumbing hardware and electrical installation for the new telescope hydraulic system are complete, while testing and debugging of the PLC control system are ongoing. The Observatory Automation Control GUI, which uses the software templates previously developed for the Observatory Automation Project (OAP), is being developed in-house at CFHT and should complement the control system seamlessly. We expect the new system to be online by mid-December.

Dome Vents:

All the dome vents have been evaluated, as a result, eight of the twelve units have been released for use. The available vents were initially restricted to the 1/3 open configuration and released for only MegaCam runs and on nights when the day crew would be present the following morning.

After a trouble-free evaluation period, the eight vents have been released for use to 2/3 open with no restrictions except for inclement weather. The vents are available seven days a week and for use with all instruments.



New Hydraulic Power unit installed at the summit.



Dome vent Nifty access.

The plan going forward is to increase the dome vent use and repair the remaining four damaged units as time permits. Brainstorming sessions have been initiated to add additional safety measures and engineering improvements that hopefully will return all twelve vents to the full open operating mode soon.

Bridge Crane Access Platform:

The dome bridge crane access platform has been installed and is fully operational.



Bridge crane access platform: design (Left) installation (Right).

Other Facility Upgrades**Headquarters Power Infrastructure:**

The battery backup system that provides power conditioning for the Waimea computing facilities failed during installation and wiring of a new UPS in May 2022 (after the original UPS failed last year.) A generator provides sustained backup power but takes a few seconds to start, making the facilities vulnerable to blackouts and brownouts. Remote observing and other computing services are at risk of being down for short periods. Individual UPS units have been installed on the critical servers in Waimea.

Primary Mirror Cosine Regulator Upgrade:

Due to competing resources and priorities, no progress has been made on the primary mirror cosine regulator project since the last May. In April 2021, a concept design review was held for the project, and a go-ahead was given to develop a prototype for testing. A prototype was assembled in late May 2021 but is not yet fully tested. Development and testing of the primary mirror cosine regulator will resume after

completing the astrometric camera project at the end of December. The cosine regulator upgrade project is expected to be completed in early 2022.

Astrometric Camera:

The astrometric camera will decrease the time to target acquisition for our narrow field of view instruments, specifically ESPaDOnS and SPIRou, by providing a secondary source of wide field of view images. The camera is fully fabricated and tested in the lab, installation on the telescope is scheduled for early to mid-December.

Maunakea Atmospheric Monitor (MKAM)

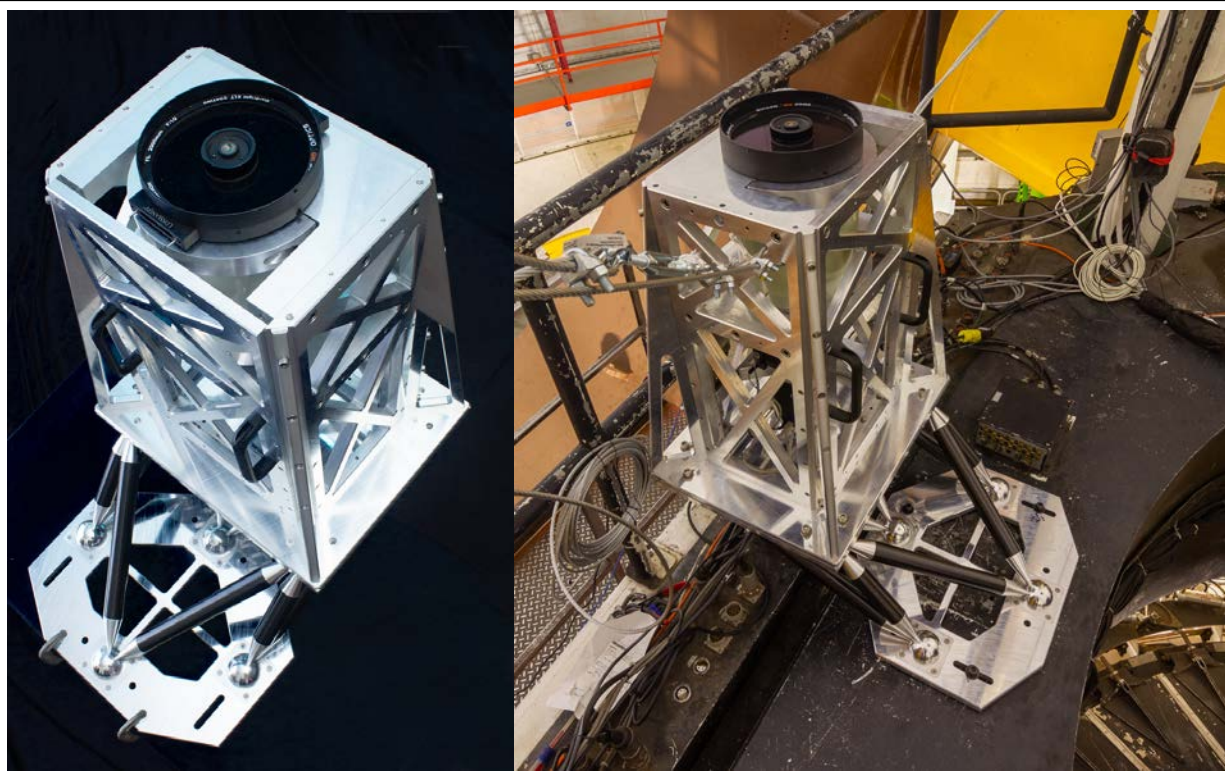

Astrometric camera and telescope stand.

The MKAM has been providing DIMM and MASS seeing measurements as a shared resource on Maunakea since 2008. In January, the dome was damaged during an ice storm. Consequently, the entire dome and telescope were removed from the tower for repair and maintenance, respectively. The telescope was already one year overdue for its regular maintenance overhaul when it was removed.

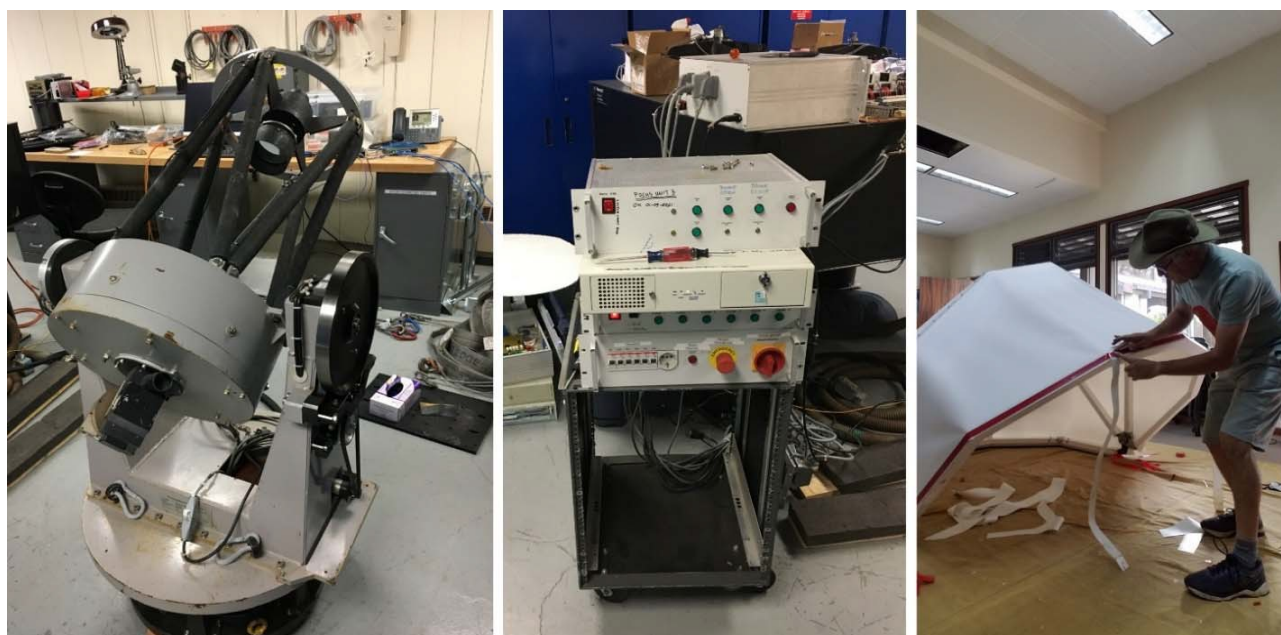

MKAM periodic maintenance and dome skin replacement. The newly purchased Nifty lift came in handy for installing the dome skin.

MSE Wide-Field Corrector (WFC) Ghost Analysis:

Control of ghost reflection contamination in the MSE WFC poses a challenge because of the low ghost threshold requirement; 25th magnitude source equivalent across the 0.36 – 1.8 μm passband. A deeper

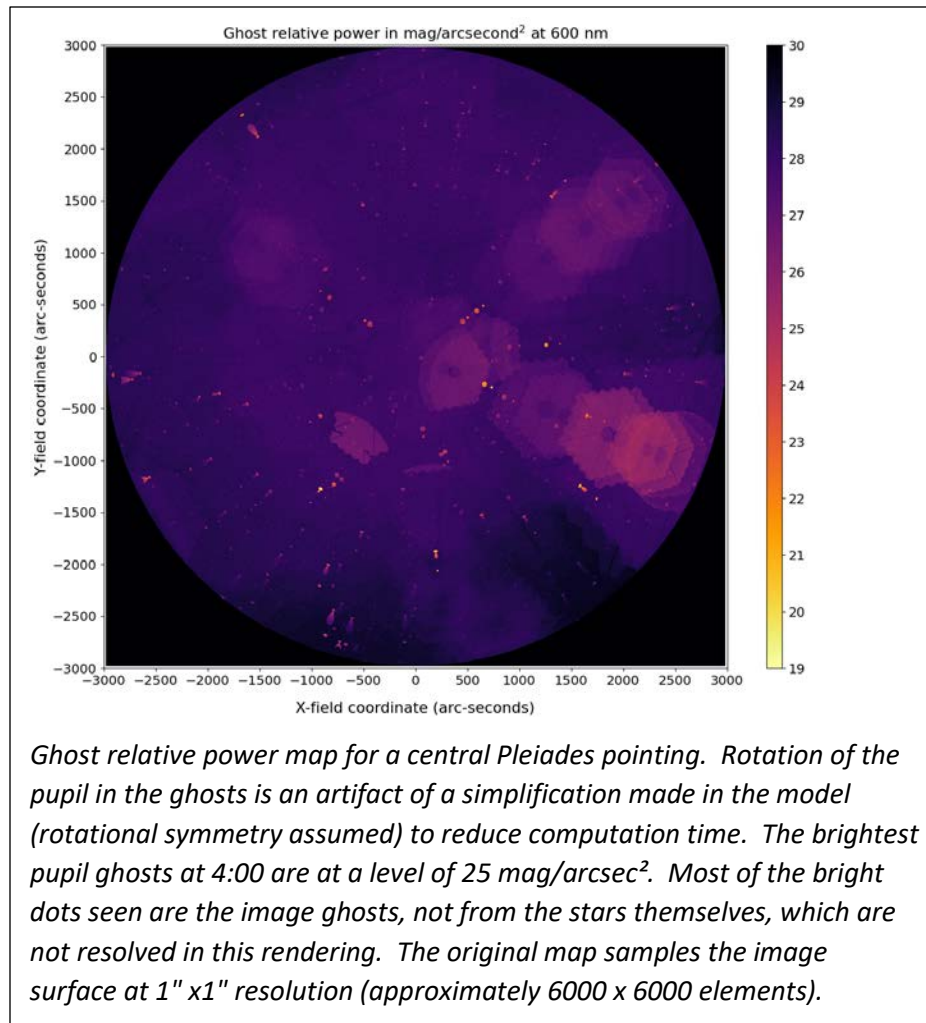

look into the ghost contributions at the beginning of 2021 flagged potential problems, prompting a validation of the Zemax analysis against an independent analysis performed by Jessica Zheng at AAO using FRED. Having confirmed that the Zemax model was correct, a more detailed look at the ghost performance was undertaken, results are pending.

Continuing analysis work will assess the impact of scattered light in the WFC and if this performance aspect lends a significant advantage to refractive designs over mirrors.

Instrumentation

MegaCam:

The GigE data transmission interface, which replaces the original SLINK interface, was deployed before the December 2020 run after another SLINK board failure that left only one working board. Note: MegaCam needs two SLINK boards, one for the Master controller and another for the Slave controller. The interface has been very stable thus far, with no significant issues.

The remaining single-point failure is the WorldFip interface. The hardware for the current VME version has been obsolete for over a decade and is not available on the secondary market.

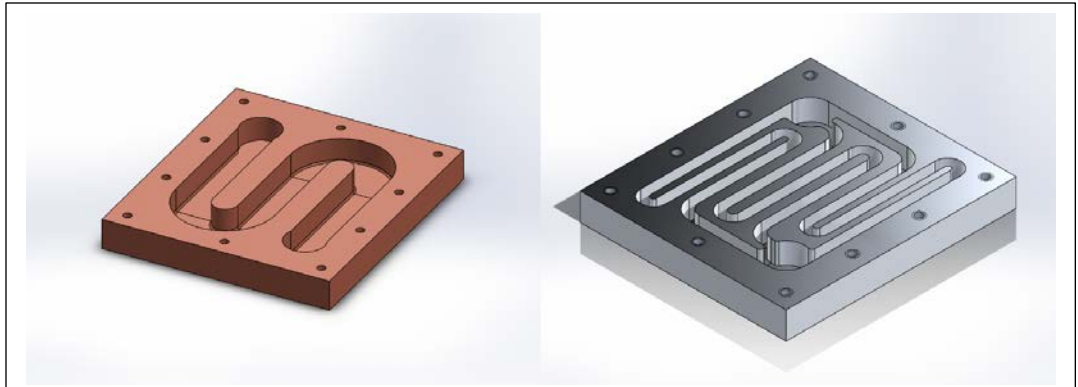

Figure 92: Tested cold plate configurations. Left is the original design which has been tested in copper and aluminum. Right is the new design, which performs better in tests.

Developing a spare solution is paramount since any WorldFip interface failure will shut down MegaCam operations. Work on a spare Linux version based on the WorldFip PCI card received from CEA last March is ongoing. The anticipated completion date is early spring 2022.

SPIRou:

SPIRou continues to function with no major failures during the semester. Work on improving SPIRou performance is ongoing though progressing slowly.

Laser Frequency Comb - The LFC failed again this semester and needed a component replaced. The component was sent by Menlo and installed by CFHT staff. The LFC is functioning again, though Menlo staff will need to be on site to tune it further to get it running at nominal levels. This work is currently on hold because of COVID-related travel restrictions.

Helium Compressors - During a warm period this summer, the fluid cooling for the SPIRou helium compressors had difficulty keeping one of the units cool enough. Introducing some forced air through the compressors reduced the temperatures sufficiently to relieve the problem. New side panels with fans attached were installed on the compressors to provide additional cooling.

SPIRou DRS - The current 0.6 version has been stable, and reprocessing of the data using this version is ongoing. The next upgrade, the 0.7 version, should be available in early 2022. Tests on 0.7 versions indicate that the reprocessing time will be significantly faster, in the order of weeks.

SPIRou Upgrade and Cryogenic System Maintenance:

The attempts by WinLight and IRAP to produce a new pupil slicer with improved scrambling over the current scrambler have, so far, been unsuccessful. Holding the fiber securely in the slicer has proven to be much more difficult than initially expected. The timeframe for the upgrade remains at late 2022A to coincide with the planned preventive maintenance on the cold heads in the spectrograph, which will require warming of the cryostat. IRAP has been informed of the need for the warmup and has confirmed that the other upgrades will be ready by late 2022A shutdown but cannot commit to having a new slicer then.

Regarding the upgrades, one is the addition of an LED to the optical bench that should allow the detector to be "flashed" between spectra to remove the structure from the persistence of the detectors. Tests of this method were done at Université de Montréal with success.

The other is a new feedthrough for the fibers that will thermally isolate the fiber interface from the cryostat. This should allow the fiber interface to be driven to a lower temperature and further reduce the thermal background from this interface.

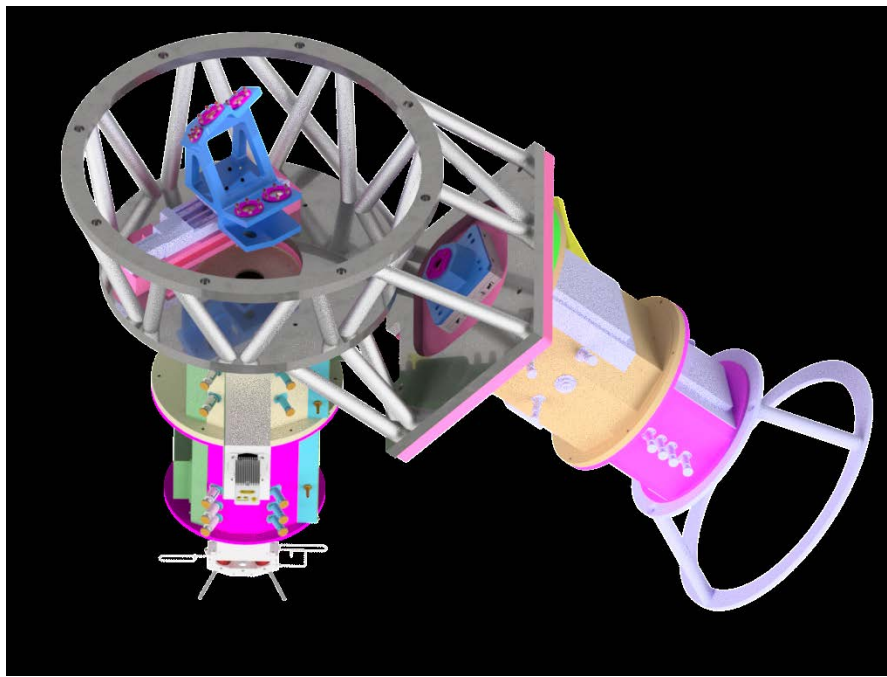

Structural concept of a co-mounted SPIRou and ESPaDOnS with both polarimeters fixed in place and a slide mechanism to facilitate one of three operating modes.

SPIRouDOnS IRAP/OMP Proposed Design

IRAP/OMP proposed a strawman conceptual design (VISION) to combine observations of ESPaDOnS and SPIRou with three modes of operation - (1) SPIRou alone, (2) SPIRou and ESPaDOnS simultaneously, and (3) ESPaDOnS alone. The virtue of this design is that any moving parts would be small, even if only Modes 1 and 3 are feasible, as in CFHT's proposed instrument exchanger concept. The VISION design attempts to address concerns raised during a preliminary concept

studied for Mode 2 at CFHT. This design reduces the incidence angle on the dichroic by 18 degrees, which in principle should reduce the angle-of-incidence (AOI) dependent polarization effects in the dichroic.

An evaluation of the polarimetric effects in Mode 2 and Mode 3 was undertaken at CFHT, and a meeting was held with IRAP/OMP stakeholders to discuss the results. We do not present CFHT's analysis here as we are still working out significant discrepancies with our outcome and the VISION team's analysis, particularly the polarization effects using the simultaneous observation Mode 2.

The science case for VISION developed by IRAP revolves around the idea of boosting the science return of SPIRou and ESPaDOnS at CFHT over the next decade by ensuring that both instruments are operated simultaneously (rather than separately). Simultaneous optical and nIR velocimetry and spectropolarimetry with ESPaDOnS and SPIRou would increase the number of spectral lines available for analysis, and therefore:

- Improve the velocimetric content of exoplanet observations (more lines, improved measurements),
- Better disentangle effects to due stellar activity (as opposed to effects due to the presence of exoplanets) by using the information present over a wider range of wavelength (chromatic effects),

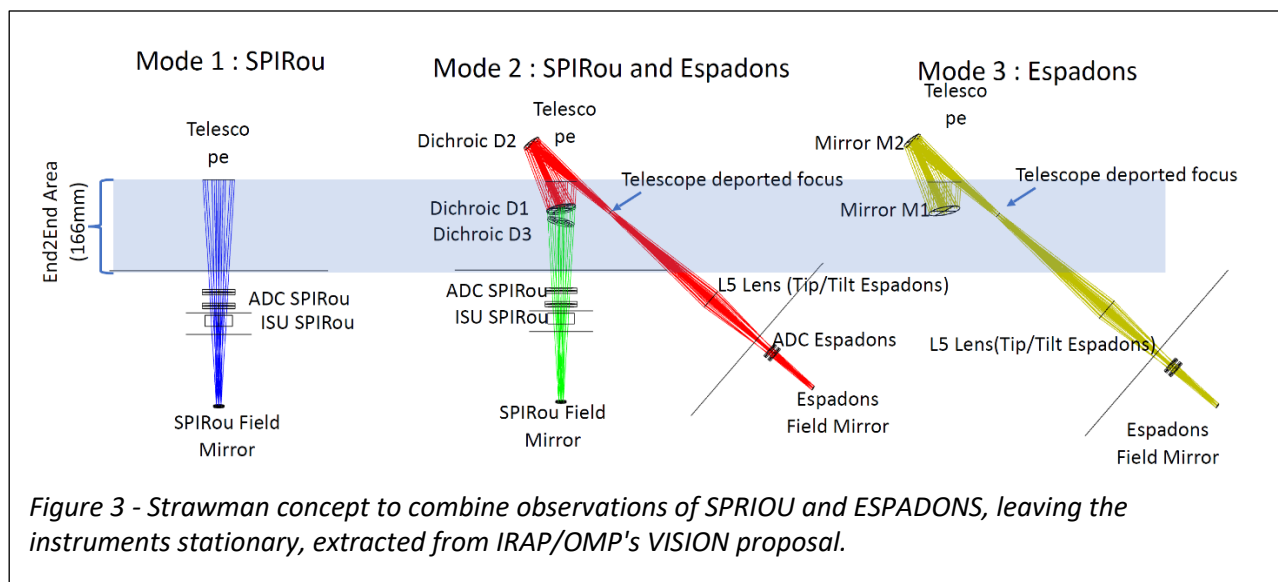

- Provide a larger sample of activity tracers, and magnetic and planetary diagnostics, over the full spectral range,
- Improve characterization of exoplanet atmospheres (more lines, lines from more atomic and molecular species),
- Improve the sensitivity for the detection of weak magnetic fields (using more spectral lines).

The benefits go beyond young stars, and extend to evolved cool stars, hot stars, and Cepheids. The full science case document is included in the appendix.

ESPaDONs/GRACES:

The science team confirmed that the CDD 42-90 detector contamination noted last quarter does not seem to affect observations. The few PIs who were contacted did not notice artifacts in their data. We will not undertake any corrective action but will continue to monitor the state of the contamination. Sending the detector to Teledyne/ e2v for cleaning is an option if the contamination worsens. Unfortunately, acquiring a reasonably priced spare is not. They do not have any detectors in their inventory that meet our requirements.

WIRCam:

There have been no issues with WIRCam. As part of the regular maintenance program, the cold head was replaced recently and should be good for two years. Also, after returning WIRCam to the cage following the f/8 realignment, the noise was slightly higher on two detectors by about 20%. Efforts are underway to reduce the noise back to normal levels.

Sitelle:

Sitelle is operating stably; no improvements have been made to the instrument since the last two semesters. Due to a long time between runs, the CCD cameras were warmed to reduce energy consumption and wear and tear on the compressors.

Software

Kealahou Development:

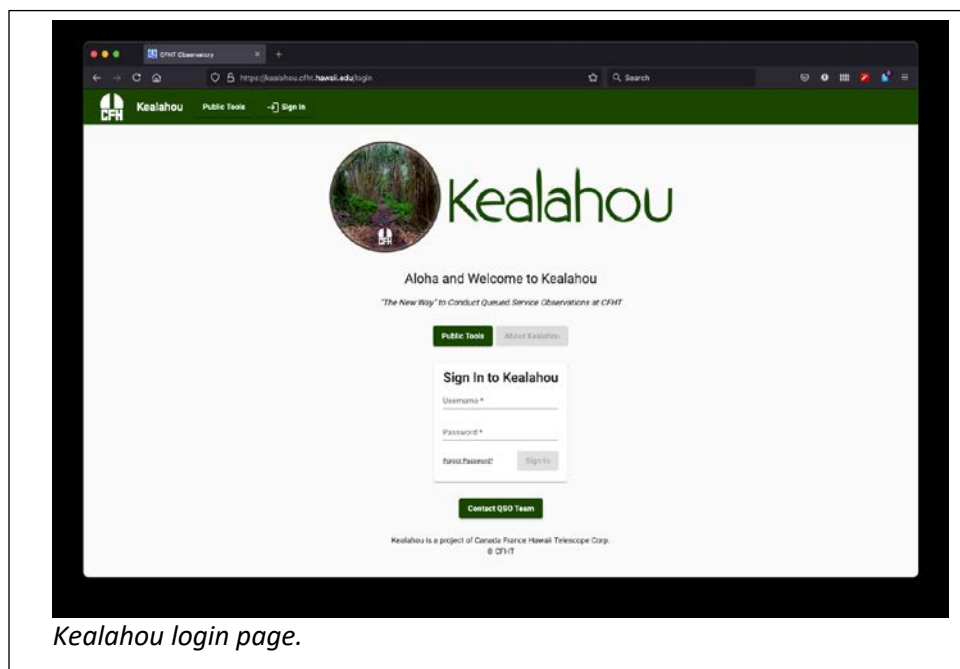

The past year has been highly productive for the Kealahou Team. In particular, three achievements stand out:

Ongoing Operational and User Support (SPIrou) - It is important to note that Kealahou is an operational QSO system and an ongoing development project. SPIrou is and has always been fully integrated with Kealahou, and as a

result, Kealahou is integral to SPIrou science operations. Without Kealahou, quite simply, SPIrou QSO observations cannot be obtained.

Due to the essential nature of Kealahou to SPIrou, the project's highest priority is the ongoing operational and user support of SPIrou and its users. During all SPIrou observing runs, the Remote Observers use Kealahou's Observing interfaces to conduct and grade all of SPIrou's QSO data. The Queue Coordinators use Kealahou's modern API to plan and construct the nightly observing queues. Additionally, K2, Kealahou's Phase 2 Tool, is used by all SPIrou's users — from the SLS Team to individual PI-led programs — to program their upcoming observations.

The Kealahou Team is actively, and on an ongoing basis, supporting the Remote Observers, Queue Coordinators, SLS Team, and individual PIs to ensure they all achieve the maximal scientific return possible with SPIrou.

Phase 2 Advanced Scheduling Modes – When SPIrou was released for QSO operations, the K2 Phase 2 Tool was not fully featured, particularly the ability to program complex, scheduled observations. The Kealahou Team has since rolled out several advanced scheduling modes, including REELs (Relational Executional Links), which link specific observing groups to other groups; Monitoring, which allows for repeated observations of specific targets at a designated cadence; Time Windows, which allow for the ability to set observations to begin at specific times and dates; and Phase Mode, which allows specific stellar phases to be programmed for observation. These modes are available to SPIrou and also to other instruments as they are transitioned to Kealahou.

Moving Targets Implementation - Similar to what was described above, for the initial SPIRou operations, there was no built-in ability to conduct observations of moving targets within Kealahou K2. This was rather painfully exposed when the QSO Team received a proposal to conduct observations of Venus in the summer of 2020. These observations were conducted successfully using several workarounds and overrides within the existing QSO and Telescope Control System (TCS) software. However, while successful, this was not a permanent solution.

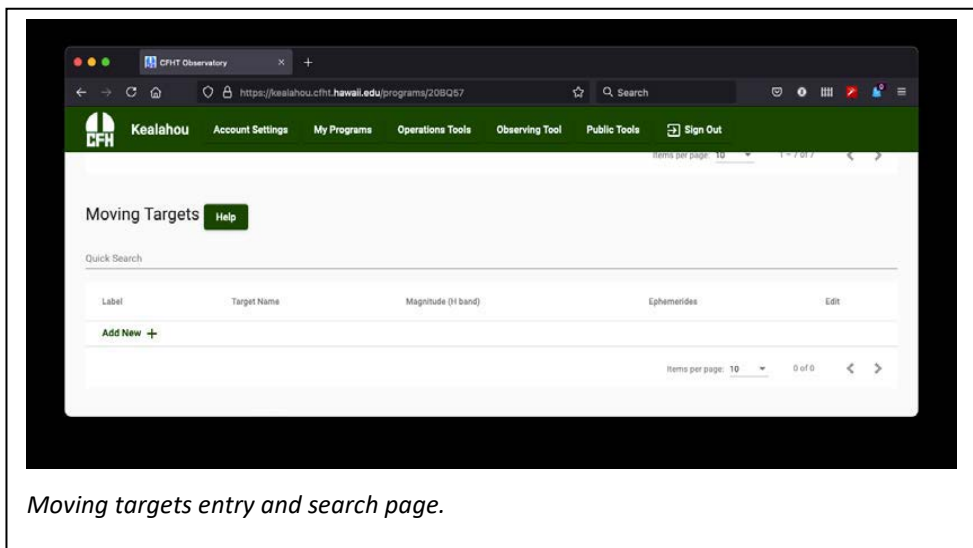

Since then, the Kealahou Team has worked to implement native functionality for moving targets. This feature is now complete and has been released to the user community. If requested by the community.

CFHT is fully capable of conducting standard QSO observations of moving targets with SPIRou, and other Kealahou-based instruments as they are moved over.

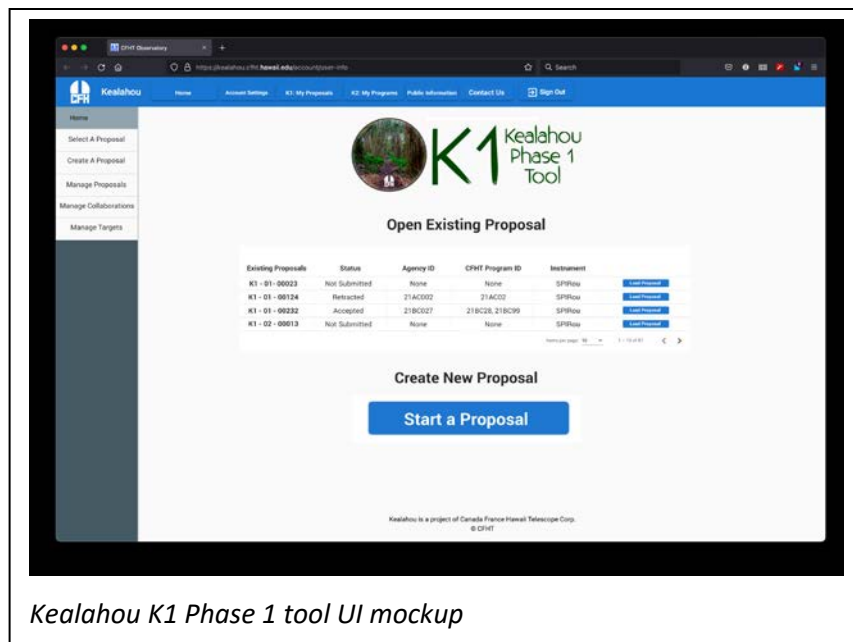

Current Project Priorities:

ESPaDONs Transition - Since the deployment of the advanced scheduling modes and moving target implementation, the primary focus of the Kealahou Team has been completing the transition of ESPaDONs to Kealahou — a process that started in Winter 2020.

K1 + K2: Integrated Phase 1 + Phase 2 - As the development effort of ESPaDONs on Kealahou wraps up, the work on the Kealahou Integrated Phase 1 Tool, K1, is increasing. While the original, optimistic completion date of the end of the year will not be achieved, the Kealahou team has made great strides on this project and has revised the timeline for Kealahou K1 development and completion.

K1 Development has been split into two distinct units: the Proposal Submission Tool and the Proposal Review Tool. The first of these, the Proposal Submission Tool, includes all functionalities related to submitting an observing proposal. This unit was selected as the first development unit as it has the most in common with the existing K2 system. Engineering design and prototyping for the Proposal Submission Tool began last month. This followed several months of requirements scoping and production of initial mockups.

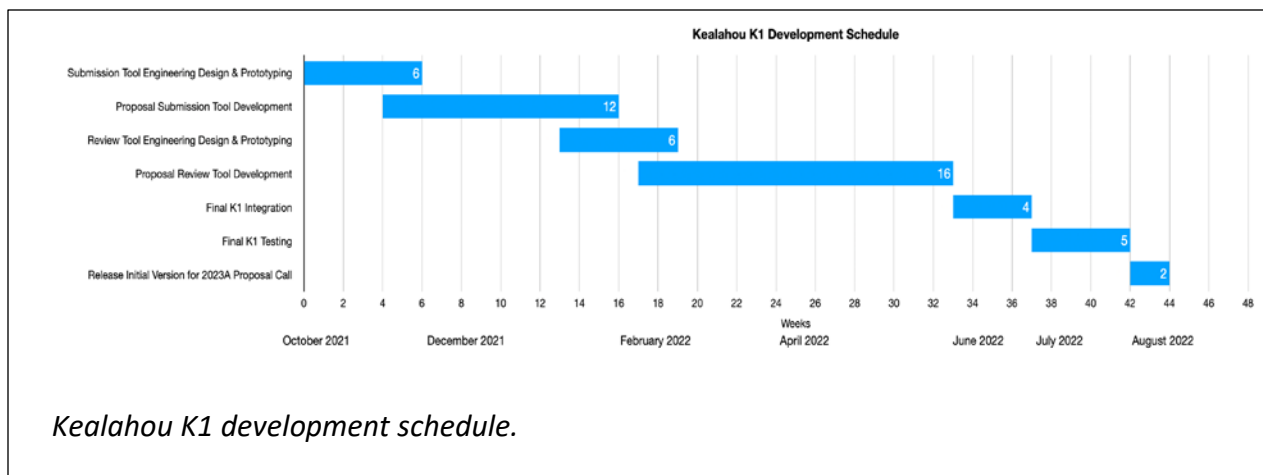

Displayed below is the project timeline. Note the anticipated completion date of August 2022, in time for the 2023A Call for Proposals.

As per the schedule, the initial release of the K1 Phase 1 Tool to the public is August 1, 2022, in time for the 2023A Call for Proposals. It is important to note that this schedule will necessitate using the NorthStar application for only one more Call for Proposals (2022B).

Project Publicity:

The Kealahou Team does not want users to be caught off guard by these changes to the QSO experience. Hence, the Kealahou Team has begun a publicity push to keep users up to date with these changes, including distinct branding for the project, with the 'Kealahou' name now.

The Kealahou Team does not want users to be caught off-guard by these changes to the QSO experience. In this vein, the Kealahou Team has begun a publicity push to keep users up to date with these changes. This includes distinct branding for the project, with the 'Kealahou' name now prominently displayed on the project web pages. This also includes newly designed project logos, a few of which are show here.



Additionally, the Kealahou Team is beginning to attend community conferences to present information on the project directly to the user community. The first of these efforts was attendance at the CASCA 2021 conference, which was held virtually in May 2021. A Kealahou poster was submitted and presented to the community here.

Summit Network Infrastructure

In 2021, broadcast traffic from other observatories started to noticeably affect the summit's network communications, which interfered with critical system functions. It mainly affected the older devices, namely the Galil servo controllers and the TCS VME I/O controller. Network problems, such as lost Galil communication and late TCS commands, seemed to occur when the unwanted traffic exceeded 60 packets/sec. After some intense sleuthing to understand the problem, it was resolved on July 16 by changing the switch configuration to block unwanted traffic. Note the diminished IP broadcast traffic

(orange line in figure below) on the summit network after the change.

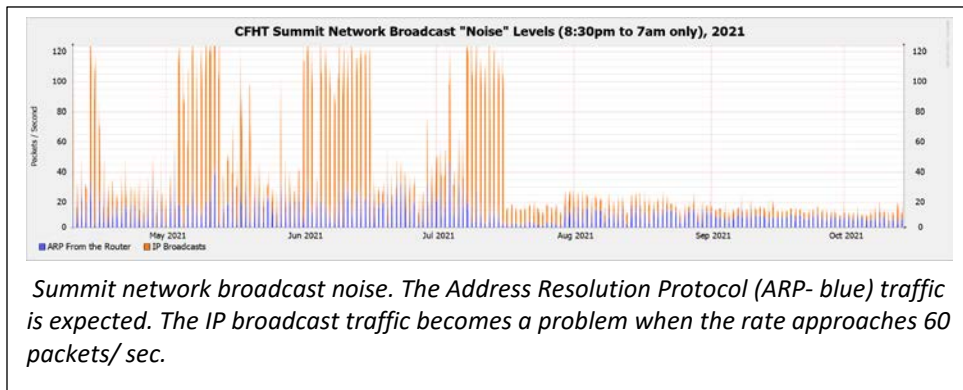

CADC Security Breach:

As a result of a security breach on CADC web servers, the existing e-transfer method used for archiving CFHT observations at CADC needed to be disabled. CADC quickly implemented a new and improved transfer method to replace the old e-transfer and helped us thoroughly test and switch over to this new method. The latest transfer method is secure, flexible, and reliable due in part to the interface code developed jointly and implemented at CADC and CFHT. We are sending observations once again and should fully catch up on the remaining backlog in the coming days-weeks. An audit found no evidence of compromised files or personally identifying information.

Adaptive Scheduling for Transit and Target Monitoring:

We evaluated multiple approaches for adaptive scheduling for transits and target monitoring at different time scales, including evaluating the adaptive scheduling tool used by Las Cumbres Observatory.

At timescales of instrument runs (i.e., 1-2 weeks) we found good opportunities. On a night-to-night basis dynamic scheduling can increase the success of observing transit events and target monitoring by adapting to missed windows of opportunity. The transit planning tool presented during the Nov. 2020 SAC meeting was developed for this purpose.

At time scales of months, we found opportunities to optimize the semester schedule, particularly when unforeseen events interrupt observing for weeks or months. Optimizing the semester schedule means changing instrument exchanges dates and other constraints. This is currently being done manually.

MSE Progress

National Strategic Planning Processes:

Given the Canadian Long-Range Plan¹ and the US National Science Foundation (NSF) Astro2020² recommendations on wide-field highly multiplexed spectroscopy priority, the Executive Director is focusing the Project Office (PO) report on programmatic considerations to enable MSE construction that anchor on anticipated Canadian and US funding at the end of this decade. To maximize our prospects of successful funding proposals resulting in two equal investments of 20% each from the Canadian and US funding agencies, the Management Group (MG) and the CFHT Board must be the champion in advancing and resolving the following elements that are essential to advance MSE into construction phase:

- Partnership model
- Funding roadmap
- Project Office budget gap
- Local community support
- Site lease and construction permit

Expanding the MSE Partnership:

For the 2019 December in-person MG meeting, a partnership building document was developed and discussed by the MG. It stated the core principles in the MSE governance to frame the partnership discussion with prospective participants. In general terms, these principles govern the shared and designated telescope time distribution, survey proposals selection, and data access rights. Although scientific leadership is normally proportional to the partners' financial commitments, which vary between large national-scale and small institutional-scale organizations, the governance principles provide smaller partners the opportunities to lead survey programs and access to science data collected under shared telescope time.

Prior to the 2019 in-person MG meeting, a full partnership model document was developed by the PO and presented to the MG. It defined the rights and responsibilities in five areas of a participant's involvement: membership, governance, science leadership, science data and publication, and technical development according to MSE's development phases and ending at science operations. In addition, the document provided guidelines to acknowledge the contributions from those astronomers who are affiliated with one of the MSE partners but had made substantial contributions during the development of the project.

At the time, the MG deemed the PO proposed partnership model to be too prescriptive for the maturity of the partnership and opted for the partnership building document instead. Regardless of the preferred partnership documents in 2019, an official partnership model is required from the MG and the Board to answer the basic questions from prospective funding agencies:

- What do MSE partners get for their financial investments in the project: a share of the observing time, a share of the science data, or something else?

¹ Final report of the Canadian Astronomical Society's 2020 Long Range Plan for Canadian Astronomy, Chapter 9: Reference Material and Appendices, Collation of all LRP2020 recommendations, p.173.

² Pathways to Discovery in Astronomy and Astrophysics for the 2020s, Section 7.6.2 Sustaining Activities: The Astronomy Mid-Scale Programs, 7-29, p.208.

- How should their use of the telescope be related to their financial investment in MSE?

Funding Roadmap:

The funding roadmap describes to prospective funding agencies and partners a credible plan and timeline for raising the construction funding required to achieve steady-state science operations. For example, the Canadian and US funding agencies will need to know and assess how MSE intends to obtain the balance of the MSE construction given their 40% investment as part of the proposal evaluation process based on the technically paced schedule derived from the Conceptual Design Phase shown below.

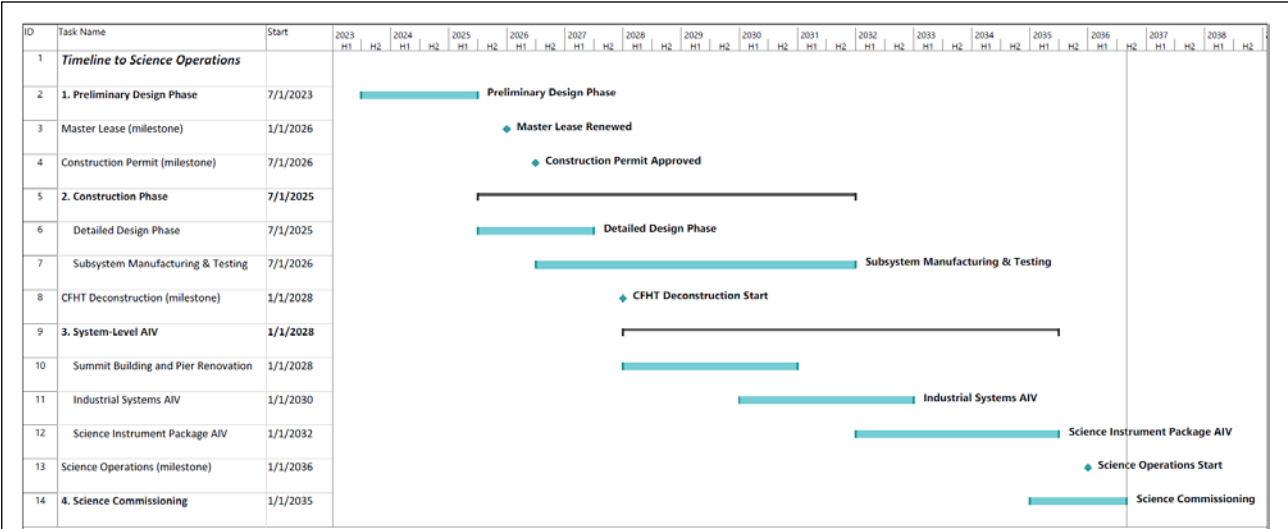

Technically paced project schedule without financial and resource constraints.
 From a project management perspective, the MSE funding timeline should match the project’s development phases spend profile, between 2023 to 2036, according to the technically paced project schedule shown in the next figure.

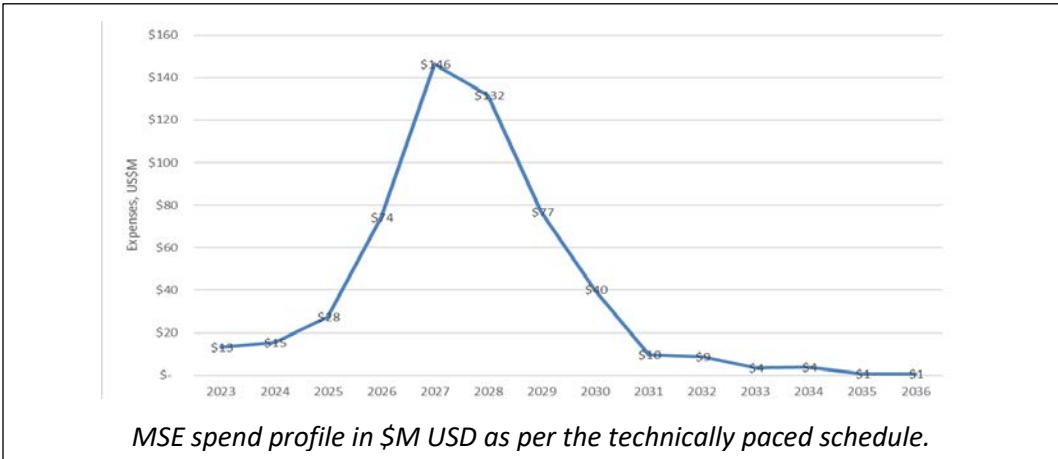

However, the time-phasing of the known funding opportunities are US NSF Mid-Scale Innovations Program in Astronomical Sciences (MSIP) and Canada Foundation for Innovation (CFI) at ~US\$20M each available in 2024, and US NSF Mid-scale Research Infrastructure-2 (MSRI-2) and Canadian federal funding at ~US\$100M each available in 2030. Figure 3 compares the accumulated spending against the accumulated funding in

the aforementioned “best-case” scenario. Even if this optimistic scenario is realized, a creditable long-term funding roadmap to bridge the apparent construction funding gap is required to gain the confidence of national funding agencies.

In-kind and CFHT Contributions Summary

As of the end of the third quarter of 2021, the year-to-date MSE participants’ in-kind contributions made to the Project total 7,677 hours in direct effort with \$0 in spending. Using \$110 per hour as a single nominal rate for direct effort, the combined contribution is valued at \$844,470 USD.

Year-to-date MSE participants contributions as of Q3 2021

Partner	In-kind Total Direct Effort (Hours)	In-kind Purchases and Travel (\$US)
Australia (AAO)	35	
Canada (HAA)	2,056	
CFHT	2,892	
China (NIAOT, USTC)	412	
France (GEPI, INSU-DT, CRAL, LAM)	312	
India (IIA)	0	
South Korea	1,050	
Spain	0	
Texas A& M	920	
Total	7,677	\$0

We continue to record both contributed effort (hours) and cost. The chart below shows the distribution of contributions by MSE participants at the end of Q3 2021 accumulated since the inception of the Project in 2015. The total combined contribution is \$13,911,968 including the direct CFHT contribution towards the Project Office and the Spanish contribution that ended in 2017. In

this chart, the in-kind contributions and Project Office contribution made by CFHT have been allocated to Canada (42.5%), France (42.5%) and Hawaii (15%).

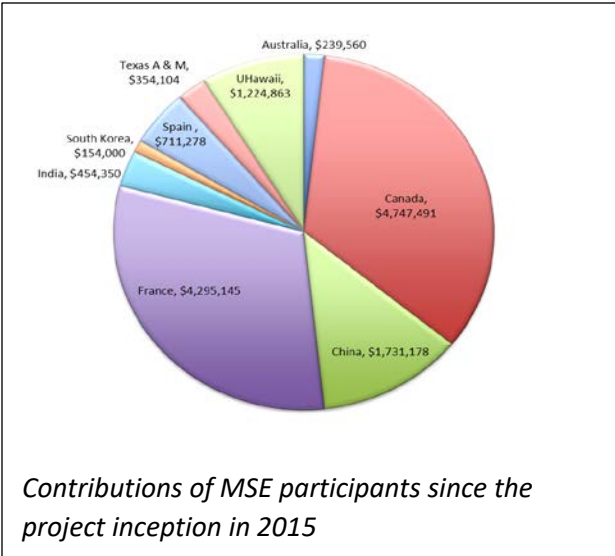
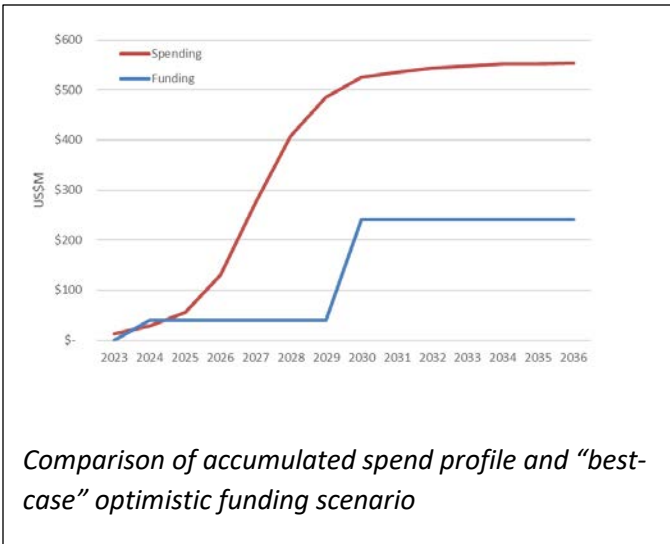

Project Office Budget Gap

In the near-term, the PO also faces an operating budget gap starting in 2023 since the current Board appropriation for MSE will end at the end of 2022. Currently, a total of 6.25 Full-Time Equivalents (FTEs) is available for the PO. The FTEs are split among 11 team members as illustrated in the figure below: three full-time members funded directly by the Board appropriation, one full-time and one 3/4-time members are funded by NRC Canada, and the remaining 1.5 FTEs are split between six part-time members with effort ranging from 1/3 to 0.1 FTEs. Of these six part-time members, three are shared CFHT staff and three are contributed effort from current MSE participants.

For planning purposes, the MG and the Board need to budget for a minimum of 6 FTEs to sustain basic PO functions such as supporting funding proposals development, enforcing configuration management,

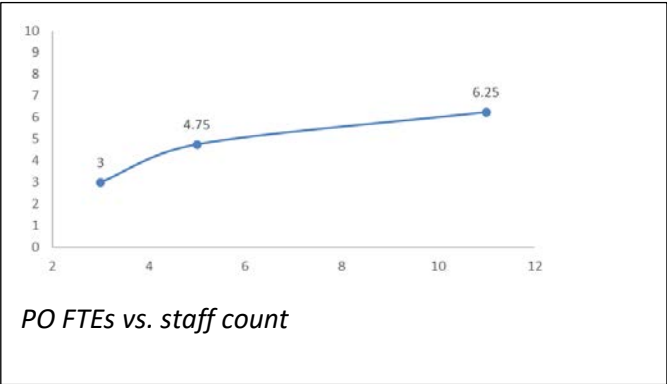

coordinating systems engineering, providing project engineering oversight on subsystem design teams, administering project management, etc. A minimum of 6 FTE is required since the NRC contributed FTEs are understood to be a time-limited commitment. Failure to bridge the PO budget gap will result in disbandment and the loss of the core project team in 2023.

Administration Report

Overview

The Finance & Administration Department supports the mission of CFHT by providing and overseeing all shared service functions of the company: Finance, Human Resources, Safety, and Office Services. The goal of the administrative group is to be helpful to the organization and provide outstanding service to our internal customers.

Summary of 2021 Finances

CFHT continues to operate in a challenging economic environment of limited member agency contributions compounded with inflationary pressures. During the last 5 years, agency contributions have grown an average of 1.4% per year. For 2021, contributions increased 1.2% from the prior year. To date, CFHT has been able to successfully balance increasing cost pressures and maintain a balanced budget due to a strategic focus on efficiency improvements in both personnel and operating costs and a disciplined eye on expenditures.

Agency Contributions (US\$)		
	2021	2020
NRC	3,500,000	3,458,740
CNRS	3,500,000	3,458,740
UH	811,591	802,024
Total	7,811,591	7,719,504

Table 1 - Contributions from CFHT partners increased 1.2% from 2020 to 2021.

As happened beginning in 2020, the COVID pandemic has significantly impacted our expenditures throughout 2021. We underspent significantly against our planned budget within our Maunakea Facilities, Management and General, and Staffing cost categories. Some of this underspending is deferred, such as capital improvements and facility maintenance, and will be incurred in coming years. Other items, such as travel and salary costs from delayed hiring, represent permanent underspending that will not be incurred in the future. While the underspending has been frustrating, an unintended upside is that additional amounts have been transferred in the Fund reserve for future needs. Table 2 shows our 2021 Operating Fund expenditures on a comparative basis with 2020. As we look towards the future, CFHT will continue to work closely with its member agencies to maintain stable and efficient operations while continuing to deliver world-class science.

Operating Fund Expenditures (US\$)		
	2021	2020
Maunakea Facility and Operations	450,830	769,415
Base Facility and Operations	312,726	209,075
Services	321,957	344,842
Maunakea Support Services	114,675	122,115
Management & General	138,576	160,108
Staffing	5,816,022	5,805,956
Outreach	72,131	58,857
Instrumentation	65,588	113,579
Science	24,342	31,829
Transfer to Reserve	494,744	103,728
Total	7,811,591	7,719,504

Table 2 - Operating expenditures broken down by cost categories.

In addition to member agency contributions, CFHT receives payments under Associate Partnership collaborative agreements with other agencies as reimbursement for costs associated with their use of CFHT facilities. In 2021, CFHT received \$202,000 and \$411,000 from the Academia Sinica Institute of Astronomy and Astrophysics (ASIAA) and the National Astronomical Observatory of China (NAOC), respectively. Money received under the collaborative agreements are used to fund instrument and project development

costs, with the current focus on MSE. Efforts are ongoing to seek additional collaborative agreements and partner with agencies throughout the world.

Environmental Health and Safety Oversight

The ongoing impacts of the COVID pandemic brought with it some very unique challenges to company health and safety. As with the rest of the world in early 2020, we entered a period of lock downs, quarantines, loss of personal connections and heightened anxiety. We started 2021 with new hope that the challenges of the prior year were behind us. Unfortunately, the Delta wave, followed by the Omicron wave, required constant changes in our approach to performing work and staffing our locations. We continue to operate with modified operations, work from home staffing arrangements when possible, and limited access of non-essential personnel to the observatory. Throughout all of these challenges, we continue delivering world class observations while making pandemic safety a top priority. We adjust our practices based on the best available guidance provided by health and government agencies. We are optimistic the biggest challenges of the pandemic are behind us. Our staff are doing their part by following the guidance of health and state officials and getting vaccinated – the company’s vaccination rate is greater than 95%.

The safety of our staff is of utmost importance. CFHT has a designated Safety Committee with members representing all departments across the company to address safety concerns or issues. The Committee meets at least monthly. Additionally, environmental, health, and safety surveys are conducted at company facilities as well as ongoing reviews of programs and processes. A new safety training program has been implemented in 2021 to better track and monitor training for all staff.

During 2020, there were no OSHA recordable injuries. In an effort to continuously improve the safety environment and culture, the company identifies and evaluates near miss and early symptom incidents in an effort to prevent more serious issues. The Safety Committee takes an active role with the EHS Manager in identifying and correcting potential safety issues.

	2021	2020	2019	2018	2017	2016	2015	2014	2013	2012
Injuries	0	0	1	1	0	0	2	2	0	0
Lost workdays	0	0	1	0	0	0	0	10.5	0	0

Table 3 – A decade of top-level statistics pertaining to safety are listed above.

In addition to staff safety, we are also focused on our environmental impact. In 2021, CFHT made the decision to decommission its underground fuel tank at the observatory. Throughout 2022, we will complete the necessary permits, inspections and activities necessary to retire the underground tank and replace it with a much smaller, more environmentally friendly above ground tank within the facility. The tank is used solely for the purpose of holding fuel reserves in case there is need for temporary emergency generation at the summit should the power grid fail.

Staff Arrivals and Departures

Over the last year we bid farewell to three of our staff 'ohana and welcomed three new members. As of year-end 2021, we had two open positions: one for a software engineer and another for a part time accountant. We anticipate those positions will be appointed and filled this year. We wish to pay tribute and extend our best wishes to those who have moved on and provide a warm welcome to our new staff members.

Farewell

Doug Simons

Doug served as the Executive Director of CFHT from May 2012 through August 2021. During Doug's tenure, CFHT commissioned two new instruments, SITELLE and SPIRou. Under his leadership, CFHT began the MSE project with the intent to repurpose the existing site with new multi-object spectroscopic technology and launch CFHT forward into a new generation of scientific discovery. Doug has moved into the role of Director of Institute for Astronomy at the University of Hawaii. We look forward to continuing our work with Doug as we plan for the future of the observatory and ongoing discovery for all facilities located on Maunakea.



Jane Rodgers

Jane retired in April 2021 after a wonderful 18-year career with CFHT. She worked in the Finance Department first as an accountant and then as Controller for the last several years. Jane was a great example of providing outstanding customer service and advocating for the needs of the staff while also maintaining all the 'behind the scenes' deadlines and deliverables on the finance function. She and her husband are enjoying their well-earned retirement staying on island and enjoying all that Hawaii has to offer. We are excited to continue seeing Jane from time to time when she stops in periodically to make sure we are still taking good care of the company cats.

Eric Dela Rosa

Eric worked at CFHT as a System Administrator from 2017 through 2021. Among his many contributions during that time, the most significant would be his technical support in assisting all staff in setting up remote offices at the beginning of the pandemic. Eric will always be remembered most for his role as Santa at the company staff dance off at the holiday party.



Welcome

Emmanuel Bertin

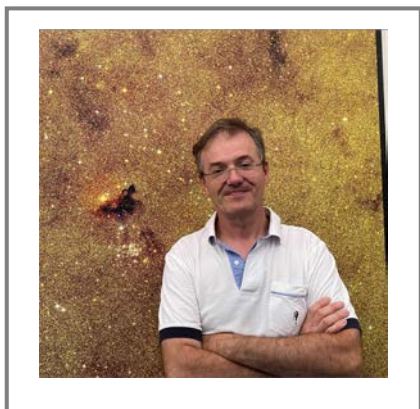

Emmanuel Bertin joined the Astronomy Group as a French Resident Astronomer, serving as MegaCam instrument scientist. Emmanuel holds a PhD in Astrophysics from Sorbonne University and has worked at several observatories in Chile, The Netherlands and in Germany before landing a position as staff astronomer at Institut d'Astrophysique de Paris in France. Emmanuel's main expertise is in the field of wide-field image processing and analysis. Over the past 30 years he has been involved in several large imaging surveys, including the ESO Imaging Survey, the CFHT Legacy Surveys and the Dark Energy Survey.

Benoît Epinat

Benoît Epinat joined the Astronomy Group as Resident Astronomer in September 2022. Benoît is supporting primarily WIRCam and also Sitelle. He received his PhD at the Laboratoire d'Astrophysique de Marseille, Aix-Marseille Université (AMU) and obtained a permanent position as Deputy Astronomer there in 2011, after a post-doc at the Institut de Recherche en Astrophysique et Planétologie (Toulouse). His research is focused on studying galaxy evolution mainly through the analysis of kinematics and dynamics of both local and intermediate redshift galaxy samples observed with integral field spectrographs.

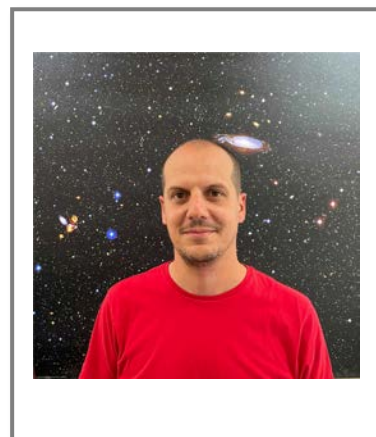

Ludvig Leto

Ludvig joined the CFHT staff in September of 2021 as a System Administrator. He moved to Hawaii from Sweden at the end of 2020 and has been working in IT for most of his life. In more recent years, Ludvig has worked as a network technician for an IaaS (Infrastructure as a Service) company, designing and implementing network solutions for its customers. Before the network focused role, Ludvig was working as an IT infrastructure consultant, analyzing and working out designs and implementation paths for the customers IT needs.



Canada-France-Hawaii Telescope Corporation
Organizational Chart

Legend

- Permanent EE's - 39.8 Current FTE positions
- Resident Astronomers - Paid by member agencies, not counted in total EE count
- MSE Project Office - 3 current FTE's

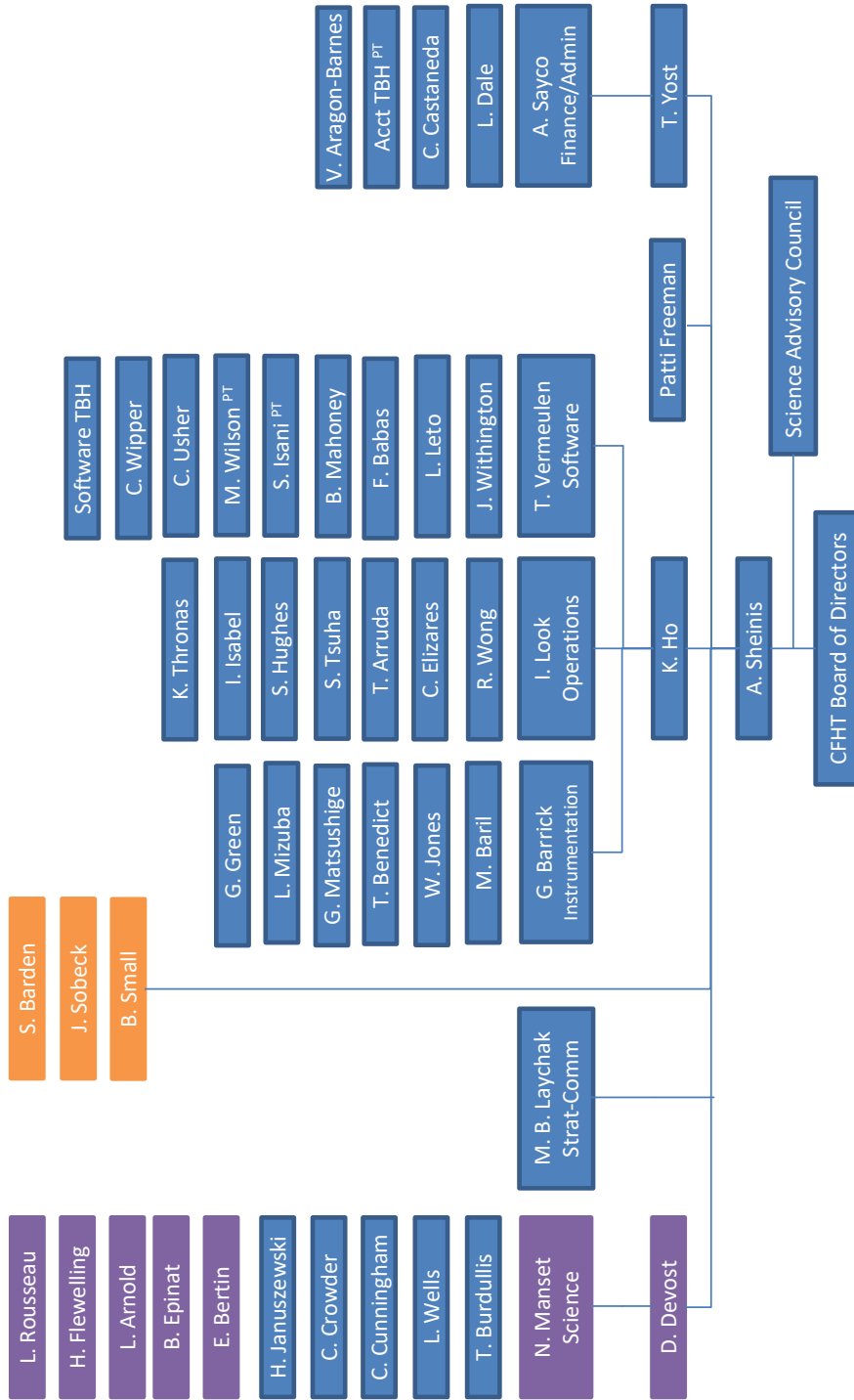

Organization Chart

Staff List as of February 2021

Name	Position	Name	Position
Aragon-Barnes, Virginia	Environmental, Health & Safety Manager	Januszewski, Helen	Remote Observer
Arnold, Luc	Resident Astronomer	Jones, Windell	Instrument Engineer
Arruda, Tyson	Mechanical Technician	Laychak, Mary Beth	Director of Strategic Communications
Babas, Ferdinand	System Administrator	Leto, Ludvig	System Administrator
Barden, Sam	MSE Systems Engineer	Look, Ivan	Operations Manager
Baril, Marc	Instrument Engineer	Mahoney, Billy	Database Specialist
Barrick, Gregory	Optical Engineer	Manset, Nadine	QSO Manager/Resident Astronomer
Benedict, Tom	Instrument Engineer	Matsushige, Grant	Sr. Instrument Specialist
Bertin, Emmanuel	Resident Astronomer	Mizuba, Les	Instrument Specialist
Burdullis, Todd	QSO Operations Specialist	Rousseau-Nepton, Laurie	Resident Astronomer
Castaneda, Carolyn	Administrative Specialist	Sayco, Arturo	Controller
Crowder, Callie	Remote Observer	Sheinis, Andy	Interim Executive Director
Cunningham, Christy	Remote Observer	Small, Barbara	MSE Project Administrator
Dale, Laurie	Administrative Specialist	Sobeck, Jennifer	MSE System Scientist
Devost, Daniel	Director of Science Operations	Thronas, Kahea	Vehicle/Facility Maintenance Specialist
Elizares, Casey	Mechanical Technician	Tsuha, Seizan	Mechanical Technician
Epinat, Benoît	Resident Astronomer	Usher, Christopher	Software Programmer
Flewelling, Heather	Instrument Scientist	Vermeulen, Tom	Software Manager
Freeman, Patti	Assistant to the Exec Director	Wells, Lisa	Remote Observer
Green, Greg	Sr. Mech Designer/Instr. Maker	Wilson, Matt	Software Engineer
Ho, Kevin	Interim Director of Engineering	Wipper, Cameron	Remote Observer
Hughes, Steve	Electrician	Withington, Kanoa	System Administrator
Isabel, Ilima	Custodian	Wong, Raycen	Mechanical Engineer
Isani, Sidik	Software Engineer	Yost, Tracy	Director of Finance and Admin.

Strategic Communications and Outreach Report

Communications Efforts

Ivan Look and Raycen Wong joined the first cohort of the Kama'āina Connection Program (KCP). Designed by Rich Matsuda at the W.M. Keck Observatory, KCP aimed to connect MKO staff members born and raised in Hawaii and elevate their voices within the MKOs and wider community. The eight sessions ran from February to April. It was through KCP that Ivan Look joined the MKO staff listening sessions facilitators group and Raycen Wong spoke with Akamai interns as part of their prep course. The second KCP cohort started in Summer 2021 and included Kevin Ho and Carolyn Castaneda.

Canada

CFHT continued writing a column in the bi-month Royal Canadian Astronomical Society's journal, entitled "CFHT Chronicles." The CFHT Chronicles debuted in the June 2015 edition. The column focuses on all aspects of CFHT; instrumentation, staff and science. Our strategy with the column is to make the work of CFHT relatable to the predominately amateur astronomy community readership and cultivate a sense of connection with CFHT. We have received nice feedback from RASC members who enjoy reading the column.

Laurie Rousseau-Nepton regularly gives talks through the [Connected North@Home](#) program to students in remote Indigenous communities across Northern Canada. CFHT staff have given a variety of one-off talks for Canadian institutions and Amateur Astronomy Associations.



In partnership with Dunlap and Discover the Universe (DU), CFHT created, filmed, edited and subtitled a [series of videos](#) to support the DU summer annual eclipse project. Each video included two First Nations eclipse myths adapted by Laurie Rousseau-Nepton. DU created classroom kits for schools along the annual eclipse path. Because many of the schools were on reserves or First Nations land, the materials and videos were translated into eight First Nations Languages, plus English and French. To acknowledge the dual national languages of Canada, each First Nations dialect was subtitled over English and French versions of the video.

As a spin-off of the DU project, CFHT worked with an 'ōlelo Hawai'i language expert to adapt a Hawaiian eclipse myth and translate the story into English and one of the First Nations myths into 'ōlelo Hawai'i.

In November, CFHT signed on as one of the sponsors of the McGill University Hack-a-thon.

Hawaii

Journey Through the Universe occurred the first two weeks of March. Journey Through the Universe is a Gemini led initiative in East Hawaii where observatory staff visit k-12 classrooms presenting science and career talks. The entire program moved online this year and was open to classrooms around Hawaii Island.

Several CFHT staff volunteered for the virtual classroom visits. The bulk of the CFHT Journey Through the Universe visits occurred in North Hawaii where the program is organized by CFHT with support from the W.M. Keck Observatory. The program reached fewer students in North Hawaii than years prior due to the Hawaii State Department of Education’s shifting landscape within schools.



COVID-19 led to the cancellation of the annual Waimea Solar System Walk last fall. To continue the tradition, CFHT collaborated with staff from the W. M. Keck Observatory and University of Hawaii Institute for Astronomy to create a self-guided, bilingual, version of the [Solar System Walk](#) along Ala Ohia Street in Waimea. Volunteers from each facility created short 2–3-minute videos about each planet in English and ‘Ōlelo Hawai‘i. The videos were uploaded to YouTube and were accessible to the public via QR code on decals along the street marking the locations of each planet to scale along the road. The event ran for 5 weeks and included a pop-up Easter egg hunt on Easter Sunday. CFHT director of strategic communications, Mary Beth Laychak, led tours of the solar system as field trips for local elementary school students. The self-guided nature of the event made it difficult to count the number of participants, but over 50 families self-reported their participation by requesting the “Solar Walk prize packs” via Google form at the end of the walk. Runners and walkers along the Solar Walk path commented they enjoyed seeing the decals while exercising.

The summer brought a bevy of interns to CFHT, working in person and virtually based on the project. The Akamai program resumed after a hiatus in 2020, but for shorter six-week internship. CFHT hosted three Akamai interns: Sydney Kim, Evan Miyahara, and Zach Mader. Sydney worked with Greg Barrick to design and 3D print housings for particle sensors to be deployed in the dome. Sydney started her summer by assembling CFHT’s new 3D printer before moving on to her design. She completed a design review, printed five housings, and deployed the housings and particle sensors in the dome. Greg continues to collect data from them. Evan worked with Ivan Look and Raycen Wong on the MSE observatory facilities (OBF). Evan did a space analysis of the basement and first floor. He also evaluated cranes throughout the building. Zach Mader worked remotely with Nadine Manset and Heather Flewelling to design a target visibility tool to show PIs and QSO team members how long a target is observable on a given night. He created a prototype, and the tool is in development.

Mary Beth Laychak had two virtual interns from Kamehameha School’s Kāpili ‘Oihana program. Jaren McMillian worked with Mary Beth and Christine Matsuda on the Maunakea Observatories’ social media account. He created a schedule, found content, and posted regularly giving Mary Beth and Christine time to work out a large MKO social media strategy. Mary Beth and Nadine had an additional two interns working on a python code to easily plot ESPaDOnS data for Maunakea Scholars Students. Ethan Lee from the Kāpili ‘Oihana program coded “espapy” to take data from an ESPaDOnS data file, plot it, and zoom in/out of user defined regions. JC Dumaslan worked with Ethan to beta test the code and create a list of spectral lines to identify on the plot. JC is a Maunakea Scholars alum who is now majoring in astronomy at the University of Hawaii. He used ESPaDOnS for his project, so he knew what to expect from the data

and plots. Heather Flewelling is currently working on upgrading the code to identify specific spectral lines.

After a year's hiatus, CFHT resumed its back-to-school welcome for students at Waimea Elementary School. Many families park on the CFHT lawn for school drop off while other students take the Nature Path behind CFHT to school. CFHT staff greeted families with back-to-school supplies, coffee, lunchbox snacks, and individually packaged donuts.



In August, the largest wildfire ever recorded in the state scorched Hawaii Island. CFHT staff in Waikoloa Village and Waiki'i Ranch were forced to evacuate their homes. No damage was done to CFHT staff's homes, but significant damage was done in Pu'ukapu Hawaiian Homesteads land in Waimea. CFHT and W.M. Keck donated to the recovery efforts, including providing hot meals for two of the homesteaders' recovery planning meetings. Efforts in the area are still underway.

Throughout the summer, CFHT staff expanded their volunteer work for Hawaii Island food insecurity efforts. Staff continue to volunteer at the Hawaii Island Food Basket in Hilo, and staff started to volunteer with the KauKau 4 Keiki program in Waimea. The US FDA program provided dry goods and fresh produce to students weekly. CFHT staff helped transporting the food, packaging and distributing.

CFHT launched a new initiative in conjunction with the St. James Community Meal. Starting in July, CFHT staff create, pack, and distribute a monthly science activity to keiki who pass through the community meal. We have distributed an average of 75 kits per month July-November and anticipate the same in December.

Maunakea Scholars started in a better position than last school year. Mary Beth is slowly able to visit students in person and schools are back to their regular calendars. She's virtually visited most schools, including schools on Hawaii Island, Molokai, Lanai and Oahu. During the Summer University of Hawaii session, Maunakea Scholars in conjunction with Manoa Academy piloted Astronomy 130 Archaeoastronomy. The course was developed by Kelly Blumenthal and Kālepa Baybayan. After Kālepa's passing, his daughter Kala worked with Kelly to finalize the content. The course was taught by a team of teachers, Kelly, Alison English, and Kala.

Mary Beth continues to be active with the Keiki Heroes Project. The project continues to create and distribute child friendly and empowering COVID related messages about vaccinations. With the US FDA and CDC approving vaccinations for keiki 5-11, the requests for materials have skyrocketed. The program is now statewide and received grants from the charitable foundations from the two largest hospitals in the state, Queens Medical Center and Kaiser. Keiki Heroes have partnered with the Hawaii Department of Education to hold Q&A featuring trusted doctors and school staff for parents. Over 16,000 Keiki

Heroes coloring books were distributed via a partnership with the Hawaii County Fire Department. Mary Beth is building new connections in the community with organizations not traditionally reached by traditional astronomy outreach efforts.

CFHT participated in a hybrid Astro Day Kona event on November 14th. We distributed make and take activities to families that attended the event but were unable to have hands on activities at our booths. Organizers estimate 500 families attended.



CFHT ended 2021 with a large outreach push with the Hawaii Science Walk, the Waimea Christmas Parade, and online stargazing. Building off the success of the Waimea Solar System Walk earlier in the year, the [Hawaii Science Walk](#) was intended as part of a larger James Webb Space Telescope event. While the in-person component of the JWST event was cancelled, the science walk will run from November 22nd through January 2nd. The walk highlights the variety of scientific research conducted in Hawaii and how that research links to the search for life in the universe.

CFHT and W.M. Keck worked with the Waimea Community Association and Waimea Christmas Parade organizers to lead efforts to distribute “goodie” bags to keiki at the Christmas Parade. The materials were distributed on December 4th and advertised the upcoming virtual Star Party. CFHT and W.M. Keck had a joint float for the parade as well.

The final scheduled event for 2021 is a modified version of the annual [Winter Star Party](#). This year we collaborated with W.M. Keck to create “Star Party at Home” kits. The kits contain an invitation to a live online stargazing event on December 11th held at the Maunakea VIS, QR codes directing visitors to CFHT and W.M. Keck staff videos, and materials to make the activities on the videos. The Star Party at Home materials were distributed at Astro Day Kona and the Waimea Christmas Parade.

Social Media

CFHT maintains FaceBook, Twitter and Instagram accounts. Posts are made daily and focus on good news coming out of CFHT with emphasis on the staff, science, instrumentation, and outreach. CFHT continues to maintain Twitter and Instagram presences. The content on all three accounts is complimentary.

2021 CFHT refereed papers list

This report presents the CFHT refereed papers published in 2021 as of late November 2021. Overall, 201 unique papers were published so far this year with 90 published using data that came directly from CFHT programs (Facility papers), 56 from research using CFHT data present in the archives and 55 papers were published using data from catalogs build using CFHT data. Various historical trends of the CFHT publications are presented below along with the number of papers per instrument for 2021. A complete list of papers follows.

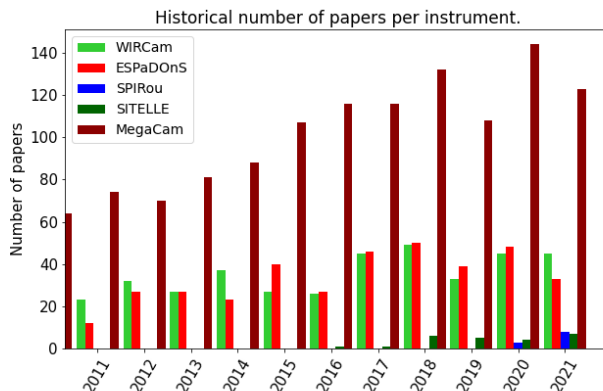
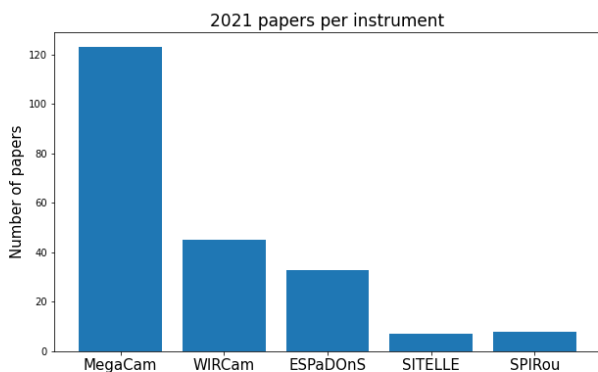
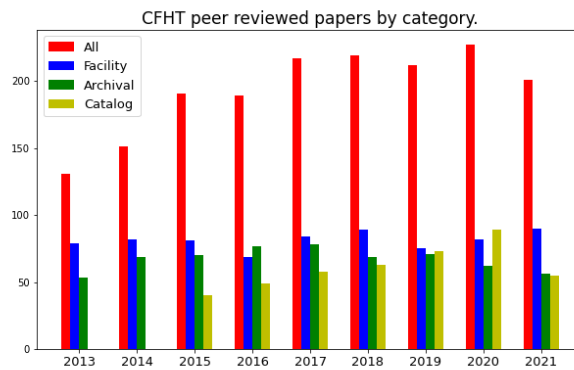
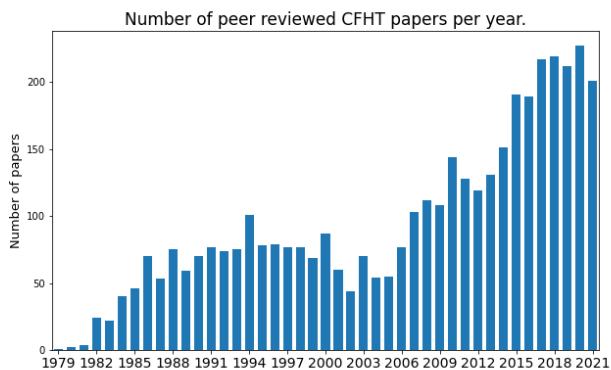
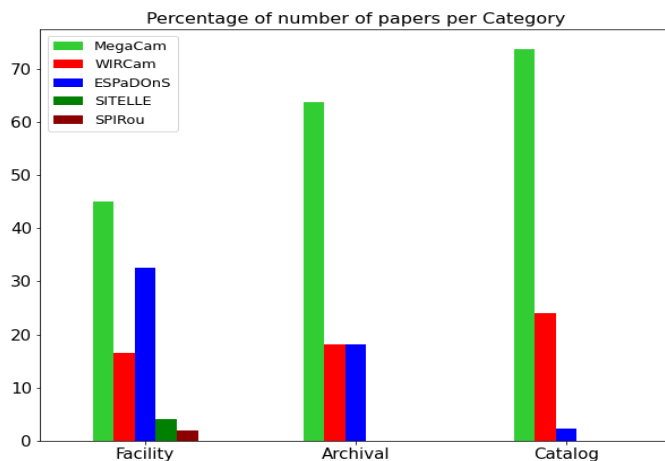

Facility (90)

Finociety, B., et al. The T Tauri star V410 Tau in the eyes of SPIRou and TESS, (2021), MNRAS, 508, 3427.

Boucher, A., et al. Characterizing Exoplanetary Atmospheres at High Resolution with SPIRou: Detection of Water on HD 189733 b, (2021), AJ, 162, 233.

Zang, W., et al. An Earth-mass planet in a time of COVID-19: KMT-2020-BLG-0414Lb, (2021), RAA, 21, 239.

Fernández-Alvar, E., et al. The Pristine survey XIII: uncovering the very metal-poor tail of the thin disc, (2021), MNRAS, 508, 1509.

McNab, K., et al. The GOGREEN survey: transition galaxies and the evolution of environmental quenching, (2021), MNRAS, 508, 157.

Bagnulo, S., & Landstreet, J. D. New insight into the magnetism of degenerate stars from the analysis of a volume-limited sample of white dwarfs, (2021), MNRAS, 507, 5902.

Feinstein, A. D., et al. H-alpha and Ca II Infrared Triplet Variations During a Transit of the 23 Myr Planet V1298 Tau c, (2021), AJ, 162, 213.

Hsia, C.-H., et al. Morphological study of the nested planetary nebula Hubble 12, (2021), A&A, 655, A46.

Adibekyan, V., et al. A compositional link between rocky exoplanets and their host stars, (2021), Sci, 374, 330.

Alexandersen, M., et al. OSSOS. XXIII. 2013 VZ₇₀ and the Temporary Coorbitals of the Giant Planets, (2021), PSJ, 2, 212.

Jensen, J., et al. Uncovering fossils of the distant Milky Way with UNIONS: NGC 5466 and its stellar stream, (2021), MNRAS, 507, 1923.

Shultz, M. E., et al. Detection of an extremely strong magnetic field in the double-degenerate binary merger product HD 144941, (2021), MNRAS, 507, 1283.

Poulain, M., et al. Structure and morphology of the MATLAS dwarf galaxies and their central nuclei, (2021), MNRAS, 506, 5494.

Kavelaars, J. J., et al. OSSOS Finds an Exponential Cutoff in the Size Distribution of the Cold Classical Kuiper Belt, (2021), ApJL, 920, L28.

Chan, J. C. C., et al. The GOGREEN Survey: Evidence of an Excess of Quiescent Disks in Clusters at 1.0, (2021), ApJ, 920, 32.

Deibert, E. K., et al. Detection of Ionized Calcium in the Atmosphere of the Ultra-hot Jupiter WASP-76b, (2021), ApJL, 919, L15.

Artigau, É., et al. TOI-1278 B: SPIRou Unveils a Rare Brown Dwarf Companion in Close-in Orbit around an M Dwarf, (2021), AJ, 162, 144.

Heesters, N., et al. Flattened structures of dwarf satellites around massive host galaxies in the MATLAS low-to-moderate density fields, (2021), A&A, 654, A161.

- Marleau, F. R., et al. Ultra diffuse galaxies in the MATLAS low-to-moderate density fields, (2021), A&A, 654, A105.
- Reeves, A. M. M., et al. The GOGREEN survey: dependence of galaxy properties on halo mass at $z > 1$ and implications for environmental quenching, (2021), MNRAS, 506, 3364.
- Higgs, C. R., & McConnachie, A. W. Solo dwarfs IV: comparing and contrasting satellite and isolated dwarf galaxies in the Local Group, (2021), MNRAS, 506, 2766.
- Mayes, R. J., et al. Testing the tidal stripping scenario of ultracompact dwarf galaxy formation by using internal properties, (2021), MNRAS, 506, 2459.
- Evensberget, D., et al. The winds of young Solar-type stars in the Hyades, (2021), MNRAS, 506, 2309.
- Erba, C., et al. Confirmation of ξ_1 CMA's ultra-slow rotation: magnetic polarity reversal and a dramatic change in magnetospheric UV emission lines, (2021), MNRAS, 506, 2296.
- Kielty, C. L., et al. The Pristine survey - XII. Gemini-GRACES chemo-dynamical study of newly discovered extremely metal-poor stars in the Galaxy, (2021), MNRAS, 506, 1438.
- Page, M. J., et al. The ultraviolet luminosity function of star-forming galaxies between redshifts of 0.6 and 1.2, (2021), MNRAS, 506, 473.
- Hainaut, O. R., et al. Elimination of a virtual impactor of 2006 QV₈₉ via deep non-detection, (2021), A&A, 653, A124.
- Ashton, E., Gladman, B., & Beaudoin, M. Evidence for a Recent Collision in Saturn's Irregular Moon Population, (2021), PSJ, 2, 158.
- McDonald, I., et al. Kepler K2 Campaign 9 - I. Candidate short-duration events from the first space-based survey for planetary microlensing, (2021), MNRAS, 505, 5584.
- Martin, T., Drissen, L., & Prunet, S. Data reduction and calibration accuracy of the imaging Fourier transform spectrometer SITELLE, (2021), MNRAS, 505, 5514.
- Dubber, S., et al. A novel survey for young substellar objects with the W-band filter III: Searching for very low-mass brown dwarfs in Serpens South and Serpens Core, (2021), MNRAS, 505, 4215.
- Pelletier, S., et al. Where Is the Water? Jupiter-like C/H Ratio but Strong H₂O Depletion Found on τ Boötis b Using SPIRou, (2021), AJ, 162, 73.
- Spite, M., Spite, F., & Barbuy, B. $^{12}\text{C}/^{13}\text{C}$ ratio and CNO abundances in the classical very old metal-poor dwarf HD 140283, (2021), A&A, 652, A97.
- Arentsen, A., et al. The Pristine Inner Galaxy Survey (PIGS) III: carbon-enhanced metal-poor stars in the bulge, (2021), MNRAS, 505, 1239.
- Shultz, M. E., et al. MOBSTER - V. Discovery of a magnetic companion star to the magnetic β Cep pulsator HD 156424, (2021), MNRAS, 504, 4850.

David-Uraz, A., et al. MOBSTER - IV. Detection of a new magnetic B-type star from follow-up spectropolarimetric observations of photometrically selected candidates★, (2021), MNRAS, 504, 4841.

Shultz, M. E., et al. NGC 6611 601: a hot pre-main-sequence spectroscopic binary containing a centrifugal magnetosphere host star, (2021), MNRAS, 504, 3203.

Fraser, W. C., et al. Col-OSSOS: The Distinct Color Distribution of Single and Binary Cold Classical KBOs, (2021), PSJ, 2, 90.

Zaire, B., Donati, J.-F., & Klein, B. Magnetic field and activity phenomena of the K2 dwarf V471 Tau, (2021), MNRAS, 504, 1969.

Bickley, R. W., et al. Convolutional neural network identification of galaxy post-mergers in UNIONS using IllustrisTNG, (2021), MNRAS, 504, 372.

Lin, H. W., et al. OSSOS: The eccentricity and inclination distributions of the stable Neptunian Trojans, (2021), Icar, 361, 114391.

Ibata, R., et al. Charting the Galactic Acceleration Field. I. A Search for Stellar Streams with Gaia DR2 and EDR3 with Follow-up from ESPaDOnS and UVES, (2021), ApJ, 914, 123.

Edwards, L. O. V., et al. Efficient Detection of Emission-line Galaxies in the Cl0016+1609 and MACSJ1621.4+3810 Supercluster Filaments Using SITELLE, (2021), AJ, 161, 255.

Hahlin, A., et al. Magnetic field of the eclipsing binary UV Piscium, (2021), A&A, 650, A197.

Biviano, A., et al. The GOGREEN survey: Internal dynamics of clusters of galaxies at redshift 0.9-1.4, (2021), A&A, 650, A105.

Junais, Boissier, et al. A Virgo Environmental Survey Tracing Ionised Gas Emission (VESTIGE). X. Formation of a red ultra-diffuse galaxy and an almost dark galaxy during a ram-pressure stripping event, (2021), A&A, 650, A99.

Ebrova, I., et al. Ubiquitous signs of interactions in early-type galaxies with prolate rotation, (2021), A&A, 650, A50.

Golob, A., et al. Classifying stars, galaxies, and AGNs in CLAUDS + HSC-SSP using gradient boosted decision trees, (2021), MNRAS, 503, 4136.

Vicentin, M. C., et al. The environment of QSO triplets at $1 \lesssim z \lesssim 1.5$, (2021), MNRAS, 503, 1507.

Higgs, C. R., et al. Solo dwarfs II: the stellar structure of isolated Local Group dwarf galaxies, (2021), MNRAS, 503, 176.

Fantin, N. J., et al. The Mass and Age Distribution of Halo White Dwarfs in the Canada-France Imaging Survey, (2021), ApJ, 913, 30.

Plachinda, S. I., Butkovskaya, V. V., & Pankov, N. F. Toward the global magnetic field of the planet-hosting red giant eps Tau, (2021), AN, 342, 607.

Deibert, E. K., et al. A Near-infrared Chemical Inventory of the Atmosphere of 55 Cancri e, (2021), AJ, 161, 209.

Sousa, A. P., et al. Star-disk interaction in the T Tauri star V2129 Ophiuchi: An evolving accretion-ejection structure, (2021), A&A, 649, A68.

Hung, D., et al. An optical observational cluster mass function at $z \sim 1$ with the ORELSE survey, (2021), MNRAS, 502, 3942.

Banik, N., et al. Evidence of a population of dark subhaloes from Gaia and Pan-STARRS observations of the GD-1 stream, (2021), MNRAS, 502, 2364.

Martin, T., Milisavljevic, D., & Drissen, L. 3D mapping of the Crab Nebula with SITELE - I. Deconvolution and kinematic reconstruction, (2021), MNRAS, 502, 1864.

Li, K.-L., et al. Revealing a New Black Widow Binary 4FGL J0336.0+7502, (2021), ApJ, 911, 92.

Lee, C.-D., et al. HO Puppis: Not a Be Star, but a Newly Confirmed IW And-type Star, (2021), ApJ, 911, 51.

Zhang, Z., et al. The Hawaii Infrared Parallax Program. V. New T-dwarf Members and Candidate Members of Nearby Young Moving Groups, (2021), ApJ, 911, 7.

Rhea, C., et al. A Machine-learning Approach to Integral Field Unit Spectroscopy Observations. II. H II Region Line Ratios, (2021), ApJ, 910, 129.

Thomas, G. F., et al. Observing the Stellar Halo of Andromeda in Cosmological Simulations: The AURIGA2PANDAS Pipeline, (2021), ApJ, 910, 92.

Petit, P., et al. Multi-instrumental view of magnetic fields and activity of ϵ Eridani with SPIRou, NARVAL, and TESS, (2021), A&A, 648, A55.

Hobson, M. J., et al. The SPIRou wavelength calibration for precise radial velocities in the near infrared, (2021), A&A, 648, A48.

Klein, B., et al. Investigating the young AU Mic system with SPIRou: large-scale stellar magnetic field and close-in planet mass, (2021), MNRAS, 502, 188.

Sévigny, M., et al. New insights into the WR nebula M1-67 with SITELE, (2021), MNRAS, 501, 5350.

Järvinen, S. P., et al. Magnetic field geometry and magnetospheric environment of the strongly magnetic Of?p star NGC 1624-2, (2021), MNRAS, 501, 4534.

Bhardwaj, A., et al. RR Lyrae Variables in Messier 53: Near-infrared Period-Luminosity Relations and the Calibration Using Gaia Early Data Release 3, (2021), ApJ, 909, 200.

Spérone-Longin, D., et al. SEEDisCS. I. Molecular gas in galaxy clusters and their large-scale structure: The case of CL1411.1–1148 at $z \sim 0.5$, (2021), A&A, 647, A156.

Bhattacharya, S., et al. The survey of planetary nebulae in Andromeda (M 31). III. Constraints from deep planetary nebula luminosity functions on the origin of the inner halo substructures in M 31, (2021), A&A, 647, A130.

Saajasto, M., et al. Multi-wavelength observations and modelling of a quiescent cloud LDN1512, (2021), A&A, 647, A109.

Piro, C., et al. Characterizing the Manx Candidate A/2018 V3, (2021), PSJ, 2, 33.

David-Uraz, A., et al. New observations of NGC 1624-2 reveal a complex magnetospheric structure and underlying surface magnetic geometry, (2021), MNRAS, 501, 2677.

Mayes, R. J., et al. Contribution of stripped nuclei to the ultracompact dwarf galaxy population in the Virgo cluster, (2021), MNRAS, 501, 1852.

Parada, J., et al. Carbon stars as standard candles - II. The median J magnitude as a distance indicator, (2021), MNRAS, 501, 933.

Liu, Q., et al. SITELLE H α Imaging Spectroscopy of $z \sim 0.25$ Clusters: Emission-line Galaxy Detection and Ionized Gas Offset in Abell 2390 and Abell 2465, (2021), ApJ, 908, 228.

Soam, A., et al. On the Collisional Disalignment of Dust Grains in Illuminated and Shaded Regions of IC 63, (2021), ApJ, 907, 93.

Massey, P., et al. The Red Supergiant Content of M31 and M33, (2021), AJ, 161, 79.

Boselli, A., et al. A Virgo Environmental Survey Tracing Ionised Gas Emission (VESTIGE). IX. The effects of ram pressure stripping down to the scale of individual HII regions in the dwarf galaxy IC 3476, (2021), A&A, 646, A139.

Aurière, M., et al. Pollux: A weak dynamo-driven dipolar magnetic field and implications for its probable planet, (2021), A&A, 646, A130.

Hamed, M., et al. Multiwavelength dissection of a massive heavily dust-obscured galaxy and its blue companion at $z \sim 2$, (2021), A&A, 646, A127.

Schrabback, T., et al. Tightening weak lensing constraints on the ellipticity of galaxy-scale dark matter haloes, (2021), A&A, 646, A73.

Liaudat, T., et al. Multi-CCD modelling of the point spread function, (2021), A&A, 646, A27.

Oi, N., et al. Subaru/HSC deep optical imaging of infrared sources in the AKARI North Ecliptic Pole-Wide field, (2021), MNRAS, 500, 5024.

Zheng, X. Z., et al. MAMMOTH: confirmation of two massive galaxy overdensities at $z = 2.24$ with H α emitters, (2021), MNRAS, 500, 4354.

Balogh, M. L., et al. The GOGREEN and GCLASS surveys: first data release, (2021), MNRAS, 500, 358.

Peca, A., et al. X-Ray Redshifts for Obscured AGN: A Case Study in the J1030 Deep Field, (2021), ApJ, 906, 90.

Vollmer, B., et al. A Virgo Environmental Survey Tracing Ionised Gas Emission (VESTIGE). VIII. Modeling ram pressure stripping of diffuse gas in the Virgo cluster spiral galaxy NGC 4330, (2021), A&A, 645, A121.

Hasinger, G., et al. The ROSAT Raster survey in the north ecliptic pole field. X-ray catalogue and optical identifications, (2021), A&A, 645, A95.

Duarte Puertas, S., et al. Searching for intergalactic star forming regions in Stephan's Quintet with SITELE. II. Physical properties and metallicity, (2021), A&A, 645, A57.

Archival (56)

Meštrić, U., et al. Upper limits on the escape fraction of ionizing radiation from galaxies at $2 \lesssim z < 6$, (2021), MNRAS, 508, 4443.

Richardson, N. D., et al. Outbursts and stellar properties of the classical Be star HD 6226, (2021), MNRAS, 508, 2002.

Ponomareva, A. A., et al. MIGHTEE-H I: the baryonic Tully-Fisher relation over the last billion years, (2021), MNRAS, 508, 1195.

Campbell-White, J., et al. The STAR-MELT PYTHON package for emission-line analysis of YSOs, (2021), MNRAS, 507, 3331.

Bernardinelli, P. H., et al. C/2014 UN₂₇₁ (Bernardinelli-Bernstein): The Nearly Spherical Cow of Comets, (2021), ApJL, 921, L37.

Torres, G., et al. Eclipsing Binaries in the Open Cluster Ruprecht 147. IV: The Active Triple System EPIC 219511354, (2021), ApJ, 921, 133.

Ragusa, E., et al. Circumbinary and circumstellar discs around the eccentric binary IRAS 04158+2805 - a testbed for binary-disc interaction, (2021), MNRAS, 507, 1157.

Marques-Chaves, R., et al. The UV-brightest Lyman continuum emitting star-forming galaxy, (2021), MNRAS, 507, 524.

Adams, N. J., et al. Evolution of the galaxy stellar mass function: evidence for an increasing M^* from $z = 2$ to the present day, (2021), MNRAS, 506, 4933.

Saha, K., et al. The central region of the enigmatic Malin 1, (2021), JApA, 42, 59.

Jones, M. G., et al. Evidence for Ultra-diffuse Galaxy Formation through Tidal Heating of Normal Dwarfs, (2021), ApJ, 919, 72.

Davidge, T. J. New Blue and Red Variable Stars in NGC 247, (2021), AJ, 162, 152.

Villa-Vélez, J. A., et al. Fitting spectral energy distributions of FMOS-COSMOS emission-line galaxies at $z \sim 1.6$: Star formation rates, dust attenuation, and [OIII] λ 5007 emission-line luminosities, (2021), A&A, 654, A153.

Polletta, M., et al. Spectroscopic observations of PHz G237.01+42.50: A galaxy protocluster at $z = 2.16$ in the Cosmos field, (2021), A&A, 654, A121.

Spérone-Longin, D., et al. SEEDisCS. II. Molecular gas in galaxy clusters and their large-scale structure: low gas fraction galaxies, the case of CL1301.7–1139, (2021), A&A, 654, A69.

Ranchod, S., et al. MIGHTEE-HI: discovery of an H I-rich galaxy group at $z = 0.044$ with MeerKAT, (2021), MNRAS, 506, 2753.

Beckett, A., et al. The relationship between gas and galaxies at $z < 1$ using the Q0107 quasar triplet, (2021), MNRAS, 506, 2574.

Denzel, P., et al. The lens SW05 J143454.4+522850: a fossil group at redshift 0.6?, (2021), MNRAS, 506, 1715.

Davies, L. J. M., et al. Deep Extragalactic Visible Legacy Survey (DEVILS): consistent multiwavelength photometry for the DEVILS regions (COSMOS, XMM-LSS, and ECDFS), (2021), MNRAS, 506, 256.

Cheng, C., et al. Searching for Low-redshift Faint Galaxies with MMT/Hectospec, (2021), ApJS, 256, 4.

Zeng, X., et al. SN 2017fgc: A Fast-expanding Type Ia Supernova Exploded in Massive Shell Galaxy NGC 474, (2021), ApJ, 919, 49.

Carrasco, E. R., et al. Dissecting the Strong-lensing Galaxy Cluster MS 0440.5+0204. II. New Optical Spectroscopic Observations in a Wider Area and Cluster Dynamical State, (2021), ApJ, 918, 61.

Mazzilli Ciraulo, B., et al. Two interacting galaxies hiding as one, revealed by MaNGA, (2021), A&A, 653, A47.

D'Eugenio, C., et al. HST grism spectroscopy of $z \sim 3$ massive quiescent galaxies. Approaching the metamorphosis, (2021), A&A, 653, A32.

Navarro Martínez, R., et al. The OTELO survey. Revealing a population of low-luminosity active star-forming galaxies at $z \sim 0.9$, (2021), A&A, 653, A24.

Alexeeva, S., et al. Spectroscopic evidence for a large spot on the dimming Betelgeuse, (2021), NatCo, 12, 4719.

Schulze, S., et al. The Palomar Transient Factory Core-collapse Supernova Host-galaxy Sample. I. Host-galaxy Distribution Functions and Environment Dependence of Core-collapse Supernovae, (2021), ApJS, 255, 29.

Perdelwitz, V., et al. CARMENES input catalog of M dwarfs. VI. A time-resolved Ca II H&K catalog from archival data, (2021), A&A, 652, A116.

Bychkov, V. D., Bychkova, L. V., & Madej, J. Catalog of averaged magnetic phase curves of stars. Second edition, (2021), A&A, 652, A31.

Casamiquela, L., et al. Abundance-age relations with red clump stars in open clusters, (2021), A&A, 652, A25.

Ivanova, A., et al. Toward a 3D kinetic tomography of Taurus clouds. I. Linking neutral potassium and dust, (2021), A&A, 652, A22.

Jones, L. H., et al. NOEMA Redshift Measurements of Extremely Bright Submillimeter Galaxies near the GOODS-N, (2021), ApJ, 916, 46.

Cont, D., et al. Detection of Fe and evidence for TiO in the dayside emission spectrum of WASP-33b, (2021), A&A, 651, A33.

Preston, J., et al. The nature of the Eastern Extent in the outer halo of M31, (2021), MNRAS, 504, 3098.

Keszthelyi, Z., et al. The effects of surface fossil magnetic fields on massive star evolution - III. The case of τ Sco, (2021), MNRAS, 504, 2474.

Dodin, A. V., & Suslina, E. A. Inhomogeneous dust eclipses in young stars: the case of CQ Tauri, (2021), MNRAS, 503, 5704.

Kóvári, Z., et al. A confined dynamo: Magnetic activity of the K-dwarf component in the pre-cataclysmic binary system V471 Tauri, (2021), A&A, 650, A158.

Roberts, I. D., et al. LoTSS jellyfish galaxies. I. Radio tails in low redshift clusters, (2021), A&A, 650, A111.

CHEX-MATE Collaboration, Arnaud, et al. The Cluster HEritage project with XMM-Newton: Mass Assembly and Thermodynamics at the Endpoint of structure formation. I. Programme overview, (2021), A&A, 650, A104.

Usher, C., et al. MUSE narrow field mode observations of the central kinematics of M15, (2021), MNRAS, 503, 1680.

Hwang, Y.-H., et al. Revisiting the Color-Color Selection: Submillimeter and AGN Properties of NUV-r-J Selected Quiescent Galaxies, (2021), ApJ, 913, 6.

Mullen, J. P., et al. Metallicity of Galactic RR Lyrae from Optical and Infrared Light Curves. I. Period-Fourier-Metallicity Relations for Fundamental-mode RR Lyrae, (2021), ApJ, 912, 144.

Teimoorinia, H., et al. An Astronomical Image Content-based Recommendation System Using Combined Deep Learning Models in a Fully Unsupervised Mode, (2021), AJ, 161, 227.

Woodcock, K., et al. τ^9 Eri: a bright pulsating magnetic Bp star in a 5.95-d double-lined spectroscopic binary, (2021), MNRAS, 502, 5200.

Shi, K., et al. Accelerated Galaxy Growth and Environmental Quenching in a Protocluster at $z = 3.24$, (2021), ApJ, 911, 46.

Zhang, W., et al. A study of the H I gas fractions of galaxies at $z \sim 1$, (2021), A&A, 648, A25.

Kondapally, R., et al. The LOFAR Two-meter Sky Survey: Deep Fields Data Release 1. III. Host-galaxy identifications and value added catalogues, (2021), A&A, 648, A3.

Kiiveri, K., et al. CODEX weak lensing mass catalogue and implications on the mass-richness relation, (2021), MNRAS, 502, 1494.

Nadolny, J., et al. The OTELO survey as a morphological probe. Last ten Gyr of galaxy evolution. The mass-size relation up to $z = 2$, (2021), A&A, 647, A89.

Nagoshi, S., et al. Discovery of a new extreme changing-state quasar with 4 mag variation, SDSS J125809.31+351943.0, (2021), PASJ, 73, 122.

Richardson, N. D., et al. The First Dynamical Mass Determination of a Nitrogen-rich Wolf-Rayet Star Using a Combined Visual and Spectroscopic Orbit, (2021), ApJL, 908, L3.

Carlsten, S. G., et al. Luminosity Functions and Host-to-host Scatter of Dwarf Satellite Systems in the Local Volume, (2021), ApJ, 908, 109.

Ghizzardi, S., et al. Iron in X-COP: Tracing enrichment in cluster outskirts with high accuracy abundance profiles, (2021), A&A, 646, A92.

Loubser, S. I., et al. Dynamical masses of brightest cluster galaxies - II. Constraints on the stellar IMF, (2021), MNRAS, 500, 4153.

Zou, S., et al. Strong Mg II and Fe II Absorbers at $2.2 < z < 6.0$, (2021), ApJ, 906, 32.

Martins, F., & Palacios, A. Spectroscopic evolution of massive stars near the main sequence at low metallicity, (2021), A&A, 645, A67.

Catalog (55)

Becker, G. D., et al. The mean free path of ionizing photons at $5 < z < 6$: evidence for rapid evolution near reionization, (2021), MNRAS, 508, 1853.

Lizardo, A., et al. Cosmography using strong-lensing systems and cosmic chronometers, (2021), MNRAS, 507, 5720.

Saldana-Lopez, A., et al. An observational determination of the evolving extragalactic background light from the multiwavelength HST/CANDELS survey in the Fermi and CTA era, (2021), MNRAS, 507, 5144.

Singhal, A., et al. Deep co-added sky from Catalina Sky Survey images, (2021), MNRAS, 507, 4983.

Kim, E., et al. The evolution of merger fraction of galaxies at $z < 0.6$ depending on the star formation mode in the AKARI NEP-Wide Field, (2021), MNRAS, 507, 3113.

Stevens, M. L., et al. The NEWFIRM HETDEX Survey: Photometric Catalog and a Conservative Sample of Massive Quiescent Galaxies at $z = 3-5$ over 17.5 deg^2 in the SHELA Field, (2021), ApJ, 921, 58.

- Huang, Y., et al. The Role of Dust, UV Luminosity and Large-scale Environment on the Escape of Ly α Photons: A Case Study of a Protocluster Field at $z = 3.1$, (2021), ApJ, 921, 4.
- Santos, D. J. D., et al. Environmental effects on AGN activity via extinction-free mid-infrared census, (2021), MNRAS, 507, 3070.
- Oates, S. R., et al. Swift/UVOT follow-up of gravitational wave alerts in the O3 era, (2021), MNRAS, 507, 1296.
- Huang, T.-C., et al. Optically detected galaxy cluster candidates in the AKARI North Ecliptic Pole field based on photometric redshift from the Subaru Hyper Suprime-Cam, (2021), MNRAS, 506, 6063.
- Kumar, R., et al. UVIT study of UV bright stars in the globular cluster NGC 4147, (2021), JApA, 42, 36.
- Katsianis, A., Yang, X., & Zheng, X. The Observed Cosmic Star Formation Rate Density Has an Evolution that Resembles a $\Gamma(a, bt)$ Distribution and Can Be Described Successfully by Only Two Parameters, (2021), ApJ, 919, 88.
- Sarron, F., & Conselice, C. J. DETECTIFz galaxy groups in the REFINE survey - I. Group detection and quenched fraction evolution at $z < 2.5$, (2021), MNRAS, 506, 2136.
- Thanjavur, K., et al. Photometric cross-calibration of the SDSS Stripe 82 Standard Stars catalogue with Gaia EDR3, and comparison with Pan-STARRS1, DES, CFIS, and GALEX catalogues, (2021), MNRAS, 505, 5941.
- Xu, K., et al. A giant central red disk galaxy at redshift $z = 0.76$: Challenge to theories of galaxy formation, (2021), SCPMA, 64, 279811.
- Gonzalez, E. J., et al. On the weak-lensing masses of a new sample of galaxy groups, (2021), MNRAS, 504, 4093.
- Cedr s, B., et al. The OTELO Survey: The Star Formation Rate Evolution of Low-mass Galaxies, (2021), ApJL, 915, L17.
- Taylor, M. A., et al. Fresh Insights on the Kinematics of M49's Globular Cluster System with MMT/Hectospec Spectroscopy, (2021), ApJ, 915, 83.
- McLeod, D. J., et al. The evolution of the galaxy stellar-mass function over the last 12 billion years from a combination of ground-based and HST surveys, (2021), MNRAS, 503, 4413.
- Soo, J. Y. H., et al. The PAU Survey: narrow-band photometric redshifts using Gaussian processes, (2021), MNRAS, 503, 4118.
- Turner, S., et al. Synergies between low- and intermediate-redshift galaxy populations revealed with unsupervised machine learning, (2021), MNRAS, 503, 3010.
- Cochrane, R. K., et al. Resolving a dusty, star-forming SHiZELS galaxy at $z = 2.2$ with HST, ALMA, and SINFONI on kiloparsec scales, (2021), MNRAS, 503, 2622.

Koushan, S., et al. GAMA/DEVILS: constraining the cosmic star formation history from improved measurements of the 0.3-2.2 μm extragalactic background light, (2021), MNRAS, 503, 2033.

Shen, L., et al. Implications of the Environments of Radio-detected Active Galactic Nuclei in a Complex Protostructure at $z \sim 3.3$, (2021), ApJ, 912, 60.

Stroe, A., & Sobral, D. ENISALA. II. Distinct Star Formation and Active Galactic Nucleus Activity in Merging and Relaxed Galaxy Clusters, (2021), ApJ, 912, 55.

Cedr s, B., et al. The OTELO survey. Faint end of the luminosity function of [O II] λ 3727 emitters at $\langle z \rangle = 1.43$, (2021), A&A, 649, A73.

Radcliffe, J. F., et al. Nowhere to hide: Radio-faint AGN in the GOODS-N field. II. Multi-wavelength AGN selection techniques and host galaxy properties, (2021), A&A, 649, A27.

Mucesh, S., et al. A machine learning approach to galaxy properties: joint redshift-stellar mass probability distributions with Random Forest, (2021), MNRAS, 502, 2770.

Seo, H., et al. gzk-colour-selected star-forming galaxies in the AKARI NEP-Deep Field, (2021), MNRAS, 502, 1933.

Lin, X., et al. Estimating Lifetimes of UV-selected Massive Galaxies at $0.5 \leq z \leq 2.5$ in the COSMOS/UltraVISTA Field through Clustering Analyses, (2021), ApJ, 911, 59.

Durret, F., et al. Jellyfish galaxy candidates in MACS J0717.5+3745 and 39 other clusters of the DAFT/FADA and CLASH surveys, (2021), A&A, 648, A63.

Gloudemans, A. J., et al. LOFAR properties of SILVERRUSH Ly α emitter candidates in the ELAIS-N1 field, (2021), A&A, 648, A7.

Duncan, K. J., et al. The LOFAR Two-meter Sky Survey: Deep Fields Data Release 1. IV. Photometric redshifts and stellar masses, (2021), A&A, 648, A4.

Bowler, R. A. A., et al. The rapid transition from star formation to AGN-dominated rest-frame ultraviolet light at $z \simeq 4$, (2021), MNRAS, 502, 662.

Kumar, R., et al. Ultraviolet Imaging Telescope (UVIT) observation of the Galactic globular cluster NGC 7492, (2021), MNRAS, 502, 313.

Ho, S. C.-C., et al. Photometric redshifts in the North Ecliptic Pole Wide field based on a deep optical survey with Hyper Suprime-Cam, (2021), MNRAS, 502, 140.

Alarcon, A., et al. The PAU Survey: an improved photo-z sample in the COSMOS field, (2021), MNRAS, 501, 6103.

Gonzalez, E. J., et al. Measuring the surface mass density ellipticity of redMaPPer galaxy clusters using weak lensing, (2021), MNRAS, 501, 5239.

Chen, B. H., et al. An active galactic nucleus recognition model based on deep neural network, (2021), MNRAS, 501, 3951.

Kashino, D., et al. The 2175 Å Dust Feature in Star-forming Galaxies at $1.3 \leq z \leq 1.8$: The Dependence on Stellar Mass and Specific Star Formation Rate, (2021), ApJ, 909, 213.

Zhou, X., et al. Spectroscopic and Photometric Redshift Estimation by Neural Networks for the China Space Station Optical Survey (CSS-OS), (2021), ApJ, 909, 53.

Hunt, L. R., et al. The Evolution of the Luminosity Function for Luminous Compact Blue Galaxies to $z = 1$, (2021), ApJ, 909, 49.

Delvecchio, I., et al. The infrared-radio correlation of star-forming galaxies is strongly M_{\star} dependent but nearly redshift-invariant since $z \sim 4$, (2021), A&A, 647, A123.

Lustig, P., et al. Compact, bulge-dominated structures of spectroscopically confirmed quiescent galaxies at $z \approx 3$, (2021), MNRAS, 501, 2659.

Busekool, E., et al. The Ursa Major association of galaxies - VI: a relative dearth of gas-rich dwarf galaxies, (2021), MNRAS, 501, 2608.

McConnachie, A. W., et al. Solo dwarfs - III. Exploring the orbital origins of isolated Local Group galaxies with Gaia Data Release 2, (2021), MNRAS, 501, 2363.

Hovis-Afflerbach, B., et al. Identifying and Repairing Catastrophic Errors in Galaxy Properties Using Dimensionality Reduction, (2021), ApJ, 908, 148.

Yang, G., et al. JWST/MIRI Simulated Imaging: Insights into Obscured Star Formation and AGNs for Distant Galaxies in Deep Surveys, (2021), ApJ, 908, 144.

Gao, H., & Jing, Y. P. Universal Conditional Distribution Function of [O II] Luminosity of Galaxies, and Prediction for the [O II] Luminosity Function at Redshift $z < 3$, (2021), ApJ, 908, 43.

Simon, P., & Hilbert, S. CFHTLenS: Galaxy bias as function of scale, stellar mass, and colour. Conflicts with predictions by semi-analytic models, (2021), A&A, 646, A71.

Calabrò, A., et al. The VANDELS survey: The relation between the UV continuum slope and stellar metallicity in star-forming galaxies at $z \sim 3$, (2021), A&A, 646, A39.

Maddox, N., et al. MIGHTEE-HI: The H I emission project of the MeerKAT MIGHTEE survey, (2021), A&A, 646, A35.

Kim, S. J., et al. Identification of AKARI infrared sources by the Deep HSC Optical Survey: construction of a new band-merged catalogue in the North Ecliptic Pole Wide field, (2021), MNRAS, 500, 4078.

Dudzevičiūtė, U., et al. Tracing the evolution of dust-obscured activity using sub-millimetre galaxy populations from STUDIES and AS2UDS, (2021), MNRAS, 500, 942.

Liang, Y., et al. Statistical Correlation between the Distribution of Ly α Emitters and Intergalactic Medium H I at $z \sim 2.2$ Mapped by the Subaru/Hyper Suprime-Cam, (2021), ApJ, 907, 3.